

TM 11-6625-316-12

DEPARTMENT OF THE ARMY TECHNICAL MANUAL

**OPERATOR AND ORGANIZATIONAL
MAINTENANCE MANUAL**

**TEST SETS
ELECTRON TUBE
TV-2/U, TV-2A/U
AND TV-2B/U**

This copy is a reprint which includes current
pages from Changes 2 through 3

HEADQUARTERS, DEPARTMENT OF THE ARMY

MARCH 1961

WARNING

DANGEROUS VOLTAGES EXIST IN THIS EQUIPMENT

Be careful when working on the 290-volt plate and screen supply circuits, or on the 115-volt ac line connections.

DON'T TAKE CHANCES!

Change now in force: C 2

TM 11-6625-316-12

* C 2

TECHNICAL MANUAL

Operator and Organizational Maintenance Manual TEST SETS, ELECTRON TUBE TV-2/U, TV-2A/U, TV-2B/U, AND TV-2C/U

TM 11-6625-316-12 }
CHANGES No. 2 } HEADQUARTERS,
DEPARTMENT OF THE ARMY
WASHINGTON 25, D. C., 11 September 1963

TM 11-6625-316-12, 16 March 1961 (as changed by C 1, 18 Sep 1961), is changed as indicated so that the manual also applies to the following equipment:

Nomenclature
Test Set, Electron Tube TV-2C/U

Order No.
4376-PP-61

The title of the manual is changed as shown above.

Page 5, paragraph 1, (as changed by C 1, 18 Sep 1961).

Subparagraph *a*. Delete the first sentence and substitute: **This manual describes Test Sets, Electron Tube TV-2/U, TV-2A/U, TV-2B/U, and TV-2C/U (fig. 1) and covers operation and the operator's and organizational maintenance. Subparagraph *b*, last line. After "TV-2B/U" add: and TV-2C/U.**

Add paragraph 1.1 after paragraph 1.

1.1. Index of Publications

Refer to the latest issue of DA Pam 310-4 to determine whether there are new editions, changes, or additional publications pertaining to this equipment. DA Pam 310-4 is a current index of technical manuals, technical bulletins, supply bulletins, lubrication orders, and modification work orders that are available through publications supply channels. The index lists the individual parts (-10, -20, -35P, etc) and the latest changes to and revisions of each equipment publication.

Delete paragraph 2 and substitute:

2. Forms and Records

a. Reports of Maintenance and Unsatisfactory Equipment. Use equipment forms and records in accordance with instructions in TM 38-750.

* This change supersedes C 1, 18 September 1961.

b. Report of Damaged or Improper Shipment. Fill out and forward DD Form 6 (Report of Damaged or Improper Shipment) as prescribed in AR 700-58 (Army), NAVSANDA Publication 378 (Navy), and AFR 71-4 (Air Force).

c. Reporting of Equipment Manual Improvements. The direct reporting by the individual user, of errors, omissions, and recommendations for improving this manual is authorized and encouraged. DA Form 2028 (Recommended changes to DA technical manual parts list or supply manual 7, 8, or 9), will be used for reporting these improvements. This form will be completed in triplicate, using pencil, pen, or typewriter. The original and one copy will be forwarded direct to: Commanding Officer, U. S. Army Electronics Materiel Support Agency, ATTN: SELMS-MP, Fort Monmouth, N. J. One information copy will be furnished to the individual's immediate supervisor (e.g., officer, noncommissioned officer, supervisor, etc).

Page 8, paragraph 7 (as changed by C 1, 18 Sep 1961). After the last sentence, add: Test Set, Electron Tube TV-2C/U is identical externally with Test Set, Electron Tube TV-2B/U.

Page 38. Delete paragraphs 32 and 33 and substitute:

32. Scope of Operator's Maintenance

The maintenance duties assigned to the operator of Test Sets, Electron Tube TV-2(*)/U are listed below together with a reference to the paragraphs covering the specific maintenance functions. The duties assigned do not require tools or test equipment other than those issued with the equipment.

- a. Daily preventive maintenance checks and services (par. 33.2).
- b. Weekly preventive maintenance checks and services (par. 33.3).
- c. Cleaning (par. 33.4).
- d. Visual inspection (par. 34).
- e. Operational check (par. 35).
- f. Removal and replacement of chassis (par. 36).
- g. Tube replacement (par. 37).
- h. Replacement of fuses and lamps (par. 39).

33. Operator's Preventive Maintenance

Preventive maintenance is the systematic care, servicing, and inspection of equipment to prevent the occurrence of trouble, to reduce downtime, and to assure that the equipment is serviceable.

a. Systematic Care. The procedures given in paragraphs 33.2 through 33.4 cover routine systematic care and cleaning essential to proper upkeep and operation of the equipment.

b. Preventive Maintenance Checks and Services. The preventive maintenance checks and services charts (par. 33.2 and 33.3) outline functions to be performed at specific intervals. These checks and services are to maintain Army electronic equipment in a combat serviceable condition; that is, in good general (physical) condition and in good operating condition. To assist operators in maintaining combat serviceability, the chart indicates what to check, how to check, and what the normal conditions are. The *references* column lists the illustrations, paragraphs, or manuals that contain detailed repair or replacement procedures. If the defect cannot be remedied by the operator, higher echelon maintenance or repair is required. Records and reports of these checks and services must be made in accordance with the requirements set forth in TM 38-750.

Add paragraphs 33.1 through 33.4:

33.1. Preventive Maintenance Checks and Services Periods

Preventive maintenance checks and services of Test Sets, Electron Tube TV-2(*)/U are required daily and weekly. Paragraphs 33.2 and 33.3 specify the items to be checked and serviced. In addition to the routine daily and weekly checks and services, the equipment should be rechecked and serviced immediately before going on a mission and as soon after completion of the mission as possible.

33.2 Daily Preventive Maintenance Checks and Services Chart

Sequence No.	Item	Procedure	References
1	Completeness	Check equipment for completeness and general condition.	Appx III.
2	Exterior surfaces	Clean exterior surfaces of the equipment.	Par. 33.4.
3	Glass	Inspect front-panel glass windows for damaged housing, broken glass, physical damage, dust, or moisture.	None.
4	Fuses	Check to determine that fuses are of the correct rating and are not defective.	Par. 39.
5	Meters	During operation (item 8), be alert for sticking meter movement.	None.
6	Lamps	During operation (item 8), observe that the lamps are not defective.	Par. 39.

Sequence No.	Item	Procedure	References
7	Knobs, switches, and controls.	During operation (item 8), observe that the mechanical action of each knob, switch, and control is smooth and free of external or internal binding.	None.
8	Operation	Operate the equipment in accordance with paragraph 35.	Par. 35.

33.3. Weekly Preventive Maintenance Checks and Services Chart

Sequence No.	Item	Procedure	References
1	Cables	Inspect external cables for cuts, cracked or gouged jackets, fraying, or kinks.	None.
2	Hardware	Inspect all exterior hardware for looseness and damage. The tube tester cover, carrying handle, hinges, and all screws must be tight and not damaged.	None.
3	Preservation	Inspect the equipment to determine that it is free of bare spots, rust, and corrosion. If these conditions exist, refer to higher echelon for repair.	None.

33.4. Cleaning

Inspect the exterior of Test Set, Electron Tube TV-2(*)/U. The exterior surfaces should be clean, and free of dust, dirt, grease, and fungus.

a. Remove dust and loose dirt with a clean soft cloth.

Warning: Cleaning compound is flammable and its fumes are toxic. Provide adequate ventilation. *Do not* use near a flame.

b. Remove grease, fungus, and ground-in dirt from the case; use a cloth dampened (not wet) with Cleaning Compound (Federal Stock No. 7930-395-9542).

c. Remove dust or dirt from plugs and jacks with a brush.

Caution. Do not press on the meter faces (glass) when cleaning; the meter may become damaged.

d. Clean the front panel, meters, and control knobs; use a soft clean cloth. If dirt is difficult to remove, use mild soap and water.

Page 39. Delete figure 6.

Page 40. Delete figure 7.

Page 47. Delete paragraphs 40 through 42 and substitute:

40. Scope of Organizational Maintenance

The maintenance duties assigned to the organizational repairman of the tube tester are listed below together with a reference to the specific maintenance function. The duties assigned do not require tools and test equipment other than those issued with the equipment.

a. Monthly preventive maintenance checks and services (par. 42.1).

b. Rustproofing and painting (par. 42.2).

c. Visual inspection (par. 43).

d. Troubleshooting by using equipment performance checklist (par. 44).

e. Replacing test adapters (par. 45).

41. Preventive Maintenance

a. Preventive maintenance is the systematic care, inspection, and servicing of equipment to maintain it in serviceable condition, prevent breakdowns, and assure maximum operational capability. Preventive maintenance is the responsibility of all echelons concerned with the equipment and includes the inspection, testing, and repair or replacement of parts that inspection and test indicate would probably fail before the next scheduled periodic service. Preventive maintenance checks and services of the tube tester at the second echelon level are made at monthly intervals unless otherwise directed by the commanding officer.

b. Maintenance forms and records to be used and maintained on this equipment are specified in TM 38-750.

42. Monthly Maintenance

Perform the maintenance functions indicated in the monthly preventive maintenance checks and services chart (par. 42.1) once each month. A month is defined as approximately 30 calendar days of 8-hour-per-day operation. If the equipment is operated 16 hours a day, the monthly preventive maintenance checks and services should be performed at 15-day intervals. Adjustment of the maintenance interval must be made to compensate for any unusual operating conditions. Equipment maintained in a standby (ready for immediate operation) condition must

have monthly preventive maintenance checks and services performed on it. Equipment in limited storage (requires service before operation) does not require monthly preventive maintenance.

Add paragraphs 42.1 and 42.2.

42.1. Monthly Preventive Maintenance Checks and Services Chart

Sequence No.	Item	Procedure	References
1	Publications	Inspect manual for completeness and to see if it is in usable condition, without missing pages. Be sure that all Changes to the manual are on hand.	DA Pam 310-4.
2	Modification work orders.	Check to see that all URGENT MWO's have been applied and that all NORMAL MWO's have been scheduled.	DA Pam 310-4.
3	Completeness	Check equipment for completeness and general condition.	Appx III and TM 11-6625-316-20P.
4	Cleanliness	Clean the exterior surfaces of the equipment.	Par. 33.4.
5	Preservation	Inspect the equipment to determine that it is free of bare spots, rust, and corrosion.	Par. 42.2.
6	Glass	Inspect front-panel glass windows for damaged housing, broken glass, physical damage, dust, or moisture.	None.
7	Fuses	Check to determine that fuses are of the correct rating and are not defective.	Par. 39.
8	Cables	Inspect external and internal cables for cuts, cracked or gouged jackets, fraying, or kinks.	None.
9	Hardware	Inspect all exterior and interior hardware for looseness and damage. The tube tester cover, carrying handle, and all bolts and screws must be tight and not damaged.	None.

Sequence No.	Item	Procedure	References
10	Meters	During operation (item 13), be alert for sticking meter movement.	None.
11	Lamps	During operation (item 13), observe that the lamps are not defective.	Par. 39.
12	Knobs, switches, and controls.	During operation (item 13), observe that the mechanical action of each knob, switch, and control is smooth and free of external and internal binding.	None.
13	Operation	Operate the equipment in accordance with paragraph 44.	Par. 44.

42.2. Touchup Painting Instructions

Clean rust and corrosion from metal surfaces by lightly sanding them with fine sandpaper. Brush two thin coats of paint on the bare metal to protect it from further corrosion. Refer to the applicable cleaning and refinishing practices specified in TM 9-213.

Page 58, appendix I. Add the following references.

DA Pam 310-4	Index of Technical Manuals, Technical Bulletins, Supply Bulletins, Lubrication Orders, and Modification Work Orders.
TM 9-213	Painting Instructions for Field Use.
TM 11-6625-316-20P	Organizational Maintenance Repair Parts and Special Tools List, Test Sets, Electron Tube TV-2/U, TV-2A/U, and TV-2B/U.
TM 38-750	The Army Equipment Record System and Procedures.

By Order of the Secretary of the Army:

EARLE G. WHEELER,
General, United States Army,
Chief of Staff.

Official:

J. C. LAMBERT,
Major General, United States Army,
The Adjutant General.

Distribution:

Active Army:

DASA (6)
USASA (2)
CNGB (1)
CofEngrs (1)
TSG (1)

CSigO (7)
CofT (1)
CofSptS (1)
USA CD Agcy (1)
USCONARC (5)

USAMC (5)	USARCARIB Sig Agcy (1)
ARADCOM (2)	Sig Fld Maint Shop (3)
ARADCOM Rgn (2)	Units org under fol TOE
OS Maj Comd (3)	(2 cy ea UNOINDC):
OS Base Comd (2)	7
LOGCOMD (2)	7-100
USAECOM (5)	11-5
USAMICOM (4)	11-6
USASCC (4)	11-7
MDW (1)	11-16
Armies (2)	11-36
Corps (2)	11-55
USA Corps (3)	11-56
USATC AD (2)	11-57
USATC Engr (2)	11-58
USATC Inf (2)	11-97
USATC Armor (2)	11-98
USASTC (5)	11-117
Instl (2) except	11-155
Ft Monmouth (65)	11-157
Svc Colleges (2)	11-500 (AA-AC) (4)
Br Svc Sch (2) except	11-557
USASCS (50)	11-587
USASESCS (100)	11-592
GENDEP (OS) (2)	11-597
Sig Dep (OS) (12)	17
Sig Sec, GENDEP (5)	17-100
Army Dep (2) except	29-1
Ft Worth (8)	29-15
Lexington (12)	29-16
Sacramento (28)	29-21
Tobyhanna (12)	29-25
APG (5)	29-26
Springfield Armory (5)	29-36
USMA (5)	29-51
USA Elet RD Actv.	29-55
White Sands (13)	29-56
USA Elet RD Actv.	29-75
Ft Huachuca (12)	29-79
USA Trans Tml Comd (1)	29-105
Army Tml (1)	29-109
POE (1)	32-56
USAOSA (1)	37
AMS (1)	37-100
WRAMC (1)	39-51
AFIP (1)	39-52
Army Pic Cen (2)	55-157
USA Mbl Spt Cen (1)	57
USA Elet Mat Agcy (12)	57-100
Chicago Proc Dist (1)	

NG: State AG (3); units—same as Active Army except allowance is one copy to each unit.

USAR: None.

For explanation of abbreviations used, see AR 320-50.

Changes now in force: C 2 and C 3

TM 11-6625-316-12

C 3

CHANGE }
No. 3 }

HEADQUARTERS
DEPARTMENT OF THE ARMY
WASHINGTON, D. C., 10 July 1974

Operator and Organizational Maintenance Manual

TEST SETS, ELECTRON TUBE
TV-2/U, TV-2A/U, TV-2B/U, AND TV-2C/U

TM 11-6625-316-12, 16 March 1961, is changed as follows:

Page 5, paragraph 1.1. Delete and substitute:

1.1 Indexes of Publications

a. DA Pam 310-4. Refer to the latest issue of DA Pam 310-4 to determine whether there are new editions, changes, or additional publications pertaining to the equipment.

b. DA Pam 310.7. Refer to DA Pam 310-7 to determine whether there are modification work orders (MWO'S) pertaining to the equipment.

Paragraph 2. Delete and substitute the following:

2. Forms and Records

a. Reports of Maintenance and Unsatisfactory Equipment. Maintenance forms, records, and reports which are to be used by maintenance personnel at all maintenance levels are listed in and prescribed by TM 38-750.

b. Report of Packaging and Handling Deficiencies. Fill out and forward DD Form 6 (Report of Packaging and Handling Deficiencies) as prescribed in AR 700-58/NAVSUP PUB 378/AFR 71-4/MCO P4030.29, and DSAR 4145.8.

c. Discrepancy in Shipment Report (DISREP) (SF 361). Fill out and forward Discrepancy in Shipment Report (DISREP) (SF 361) as prescribed in AR 55-38/NAVSUPINST 4610.33/AFM 75-18/MCO P4610.19A, and DSAR 4500.15.

2.1 Reporting of Errors

The reporting of errors, omissions, and recommendations for improving this Duplication by the individual user is encouraged.

Reports should be submitted on DA Form 2028 (Recommended Changes to Publications and Blank Forms) and forwarded direct to Commander, US Army Electronics Command, ATTN: AMSEL-MA-C, Fort Monmouth, NJ 07703.

Page 7, paragraph 5. Delete and substitute:

5. Item Comprising an Operable Equipment

Test Sets, Electron Tube TV-2/U, TV-2A/U, TV-2B/U, and TV-2C/U (6625-669-0263) each comprises an operable equipment,

Page 11, paragraph 9c. Delete the second sentence.

Page 61, appendix III. Delete appendix III in its entirety (including final foldout, entitled: Items Comprising an Operable Equipment).

By Order of the Secretary of the Army:

CREIGHTON W. ABRAMS
General, United States Army
Chief of Staff

Official:

VERNE L. BOWERS
Major General, United States Army
The Adjutant General

Distribution:

Active Army:

USASA (2)	Corps (2)
CNGB (1)	HISA (Ft Monmouth) (18)
ACSC-E (2)	Ft Gordon (10)
Dir of Trans (1)	Ft Huachuca (10)
COE (1)	Ft Carson (5)
TSG (1)	Ft Richardson (ECOM Oft) (2)
USAARENBD (1)	WSMR (1)
USAMB (10)	Svc Colleges (1)
AMC (1)	USASESS (15)
MICOM (2)	USAINTCS (3)
TECOM (2)	USAADS (2)
TRADOC (2)	USAFAS (2)
ARADCOM (2)	USAARMS (2)
ARADCOM Rgn (2)	USAIS (2)
OS Maj Cored (4)	USAES (2)
LOGCOMD (3)	AD (1) except
USACC (4)	SAAD (30)
MDW (1)	LBAD (14)
Armies (2)	TOAD (14)

ATAD (10)	17
USA Dep (2)	29-1
Sig Sec USA Dep (2)	29-15
Sig Dep (2)	29-16
MAAG (1)	29-21
USARMIS (1)	29-26
ATS (1)	29-26
WRAMC (1)	29-36
USAERDAA (1)	29-55
USAERDAW (1)	29-56
Sig FLDMS (1)	29-105
Units org under fol TOE: 1 ea.	29-109
7	29-134
7-100	29-186
11-16	32-56
11-36	37
11-97	39-51
11-98	55-157
11-117	57
11-302	57-100
11-500 (AA-AC)	

ARNG: State AG (3).

USAR: None

For explanation of abbreviations used, see AR 310-50.

TECHNICAL MANUAL } DEPARTMENTS OF THE ARMY
 No. 11-6625-316-12 } AND THE AIR FORCE
 TECHNICAL ORDER } WASHINGTON 25, D. C., 16 March 1961

**TEST SETS, ELECTRON TUBE TV-2/U, TV-2A/U,
 AND TV-2 B/U**

	Paragraph	Page
CHAPTER 1. INTRODUCTION		
Section I. General		
Scope _ _ _ _ _	1	5
Forms and records _ _ _ _ _	2	5
II. Description and data		
Purpose and use _ _ _ _ _	3	6
Technical characteristics _ _ _ _ _	4	6
Components of Test Set, Electron Tube TV-2(*)/U.	5	7
Description of Test Set, Electron Tube TV-2(*)/U.		
Differences in models _ _ _ _ _	6	8
CHAPTER 2. OPERATION		
Section I. Service upon receipt of equipment		
Unpacking _ _ _ _ _	7	8
Checking unpacked equipment _ _ _ _ _	8	10
II. Operator's controls and indicators _ _ _ _ _	9	10
Damage from improper settings _ _ _ _ _	10	12
Operating controls and indicators _ _ _ _ _	11	12
Tube test data _ _ _ _ _	12	16
III. Preliminary operating procedures		
Operating precautions _ _ _ _ _	13	19
Tube test sockets and test adapters _ _ _ _ _	14	19
Preliminary starting procedure _ _ _ _ _	15	20
IV. Operation under usual conditions		
Starting procedures _ _ _ _ _	16	22
Zero adjustment of PERCENT QUALITY meter.	17	23

* This manual supersedes so much of TM 11-2661, 11 May 1955, including C4, 8 November 1957; C5, 21 April 1958; C6, 15 May 1959, as pertains to operator's and organizational maintenance and so much of TM 11-6625-316-12P, 23 July 1959, as pertains to the basic issue items list and the maintenance allocation chart.

	Paragraph	Page
Section IV.	Short test _____	18 23
	Interelement leakage test _____	19 24
	Filament continuity test _____	20 25
	Transconductance test _____	21 25
	Gas test _____	22 26
	Emission test _____	23 27
	Voltage regulator and gas rectifier test _____	24 28
	Procedure for reading plate current (less than 50 milliamperes) of triode tubes.	25 29
	Thyratron test _____	26 30
	Electron-ray indicator test _____	27 31
	Ballast tube test _____	28 32
	Indicator lamp test _____	29 32
	Complete tube test _____	30 33
	Stopping procedure _____	31 37
CHAPTER 3.	PERATOR'S MAINTENANCE	
	General _____	32 38
	Preventive maintenance _____	33 38
	Visual inspection _____	34 41
	Operational checklist _____	35 41
	Removal and replacement of chassis _____	36 44
	Tube replacement _____	37 45
	Preferred-type tubes _____	38 45
	Replacement of fuses and lamps _____	39 46
4.	ORGANIZATIONAL MAINTENANCE	
	General _____	40 47
	Tools and materials require _____	41 47
	Preventive maintenance _____	42 47
	Visual inspection _____	43 48
	Equipment performance checklist _____	44 48
	Replacement of test adapters _____	45 54
5.	SHIPMENT, LIMITED STORAGE, AND DEMOLITION TO PREVENT ENEMY USE.	
Section I.	Shipment and limited storage	
	Disassembly of equipment _____	46 55
	Repackaging for shipment or limited storage _____	47 55
II.	Demolition of materiel to prevent enemy use	
	Authority for demolition _____	48 57
	Methods of destruction _____	49 57
APPENDIX I.	REFERENCES _____	-- 58
	II. MAINTENANCE ALLOCATION _____	-- 59
	III. BASIC ISSUE ITEMS LIST _____	-- 64

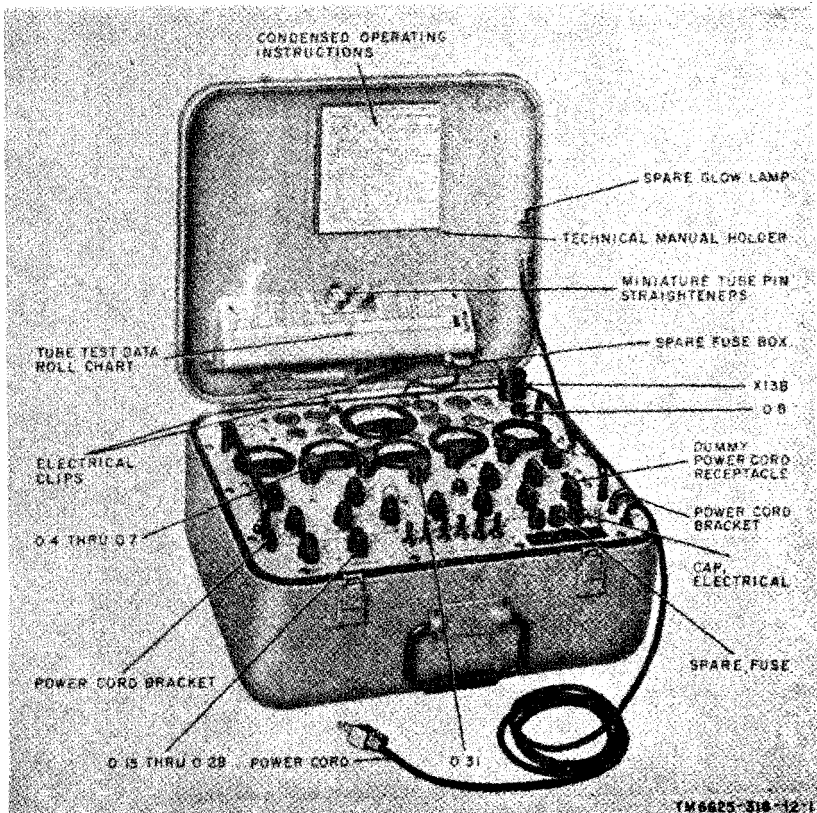

Figure 1. Test Set, Electron Tube TV-2(*)/U, less running spares.

CHAPTER 1

INTRODUCTION

Section I. GENERAL

1. Scope

a. This manual describes Test Sets, Electron Tube TV-2/U, TV-2A/U, and TV-2B/U (fig. 1) and covers operation and the operator's and organizational maintenance. It includes instructions for operation under usual conditions, for cleaning and inspection of the equipment, and for replacement of parts available to first and second echelon maintenance.

b. Official nomenclature followed by (*) is used to indicate all models of the equipment item covered in this manual. Thus Test Set, Electron Tube TV-2 (*)/U represents Test Sets, Electron Tube TV-2/U, TV-2A/U, and TV-2B/U.

c. Throughout this manual, Test Set, Electron Tube TV-2 (*) /U is referred to as the *tube tester*.

2. Forms and Records

a. *Unsatisfactory Equipment Report*. Fill out and forward DD Form 787-1 (Electronic Failure Report, Signal Equipment) to the Commanding Officer, U.S. Army Signal Materiel Support Agency, ATTN: SIGMS-ML, Fort Monmouth, N. J., as prescribed in AR 700-39.

b. *Report of Damaged or Improper Shipment*. Fill out and forward DD Form 6 (Report of Damaged or Improper Shipment) as prescribed in AR 700-58.

c. *Preventive Maintenance Forms*. Prepare DA Form 11-266 (figs. 6, 7, and 9) (Maintenance Check List for Signal Equipment (Test Equipment)) in accordance with instructions on the form.

d. *Parts List Form*. Forward DA Form 2028 (Recommended Changes to DA Technical Manual Parts Lists or Supply Manuals 7, 8, or 9), directly to the Commanding Officer, U.S. Army Signal Materiel Support Agency, ATTN: SIGMS-ML Fort Monmouth, N. J., with comments on parts listings.

e. *Comments on Manual*. Forward all other comments on this publication directly to the Commanding Officer, U.S. Army Signal

Materiel Support Agency, ATTN: SIGMS-PA2d, Fort Monmouth, N.J.

Section II. DESCRIPTION AND DATA

3. Purpose and Use

Test Set, Electron Tube TV-2(*)/U (fig. 1) is a portable tube tester of the dynamic mutual conductance type. It is used to test and to measure performance capabilities and to determine rejection limit for electron tubes used in receivers, low-powered transmitters, and other electronic equipment. The following tests can be made with the tube tester.

- a. Short test.
- b. Interelement leakage test.
- c. Filament continuity test.
- d. Dynamic mutual conductance test for amplifier tubes.
- e. Gas test for amplifier tubes.
- f. Emission test for vacuum rectifier tubes.
- g. Test of gas rectifier tubes.
- h. Test of voltage regulator tubes.
- i. Plate current tests for triodes.
- j. Test of thyatron tubes.
- k. Electron-ray indicator test for electronic indicator tubes.
- l. Ballast tube test.

4. Technical Characteristics

a. Power supply:

Input voltage _____ 103.5 to 126.5 volts ac.
Frequency----- 50 to 1,000 cps, single-phase.
Power consumption -----70 watts (no tube under test).
Temperature range ----- Satisfactory operation from -4° F. to 125° F.

b. Meters:

FILAMENT VOLTS meter:

Type----- Dc voltmeter movement.
Frequency range ----- 50 to 1,000 cps.
Ac voltage ranges ----- 0 to 2.5 volts, 0 to 10 volts, 0 to 40 volts, and
0 to 120 volts. Redlines at 0.625, 6.3, 12.6,
and 117 on appropriate scale.
Accuracy ----- ±5 percent error at full scale.

GRID BIAS VOLTS meter:

Type -----Dc voltmeter.
Sensitivity ----- 1,000 ohms per volt.
Dc voltage ranges ----- 0 to 5 volts, 0 to 10 volts, and 0 to 50 volts.
Accuracy----- ±2 percent error at full scale.

PLATE meter:

Type ----- DC voltmeter.
 Sensitivity ----- 1,000 ohms per volt.
 Voltage ranges. ----- 0 to 250 volts dc, with redlines at 45, 90, 180,
 and 225.
 0 to 50 volts ac, with 20 AC and 35 AC marked
 in red.
 Ohmmeter ranges ----- 0.1 to 1.0 megohms.
 Accuracy ----- ±2 percent error at full scale.

SCREEN VOLTS meter:

Type ----- Dc voltmeter.
 Sensitivity ----- 1,000 ohms per volt.
 Voltage range ----- 0 to 250 volts dc.
 Accuracy ----- ±2 percent error at full scale.

SIGNAL meter:

Type ----- Ac iron vane-type ammeter.
 Frequency range ----- .50 to 1,000 cps.
 Meter range ----- 45 ma ac full scale; redline at approximately
 two-thirds full scale (35 ma ac).
 Accuracy ----- ±5 percent error at full scale.

PERCENT QUALITY meter (transconductance):

Type ----- Dc microammeter.
 Sensitivity ----- 10,000 ohms per volt (150 microamperes full-
 scale deflection).
 Percent quality ranges ----- To 60,000 micromhos (in equivalent percentage
 values).
 Accuracy ----- ±2 percent error at full scale.

c. Number of electron tubes ----- 3

5. Components of Test Set, Electron Tube TV-2(*)/U

a. Components.

Quantity	Item	Height (in.)	Depth (in.)	Width (in.)	Unit weight (lb)
1	Test Set, Electron Tube TV-2(*)/U	8 3/4	16 1/2	17 1/2	37
2	TM 11-6625-816-12				
1	9-pin miniature tube straightener				
1	7-pin miniature tube straightener				
1 set	Running spares (b below)				

b. Running Spares.

Quantity	Item	Ref symbol
1	Electron tube, 83-----	V1
1	Electron tube, 6X4W-----	V2, V3
5	Fuses, 3 ampere, 250 volts, ¼ x 1¼ inches.	F1, F2
1	Glow lamp, NE-51 _____	11C, 12C

Note. Running spares listed above are stored in designated positions on the inside cover and chassis (figs. 1 and 8) of the tube tester.

6. Description of Test Set, Electron Tube TV-2(*)/U
(fig. 1)

a. Test Set, Electron Tube TV-2(*)/U (tube tester) is housed in a carrying case equipped with a carrying handle, two electrical clips for connection to the top cap of a tube under test, operating and spare tubes, fuses, indicating lamps, and miniature tube pin straighteners. The cover is secured to the case by luggage-type fasteners. Power cord brackets and a dummy power cord receptacle on the panel are used to secure and store the power cable. Tube test data is given on a roll chart; the roll chart case is mounted inside the cover of the tube tester. A condensed summary of operating instructions also is mounted inside the cover of the tube tester. The cover is hinged by slip hinges and can be removed from the case. Two handles attached to the panel permit easy lifting of the tube tester from the case.

b. All indicating meters, switches, controls, and tube test sockets are located on the panel of the equipment. The necessary data for setting and operating the controls to test the various tube types are contained in the tube test data roll chart (a above). Two electrical clips (A and B, fig. 3) provide connection to external caps of tubes as required. One end of the power cord is permanently attached to the panel; the other end terminates in a male plug.

7. Differences in Models

Test Sets, Electron Tube TV-2/U, TV-2A/U, and TV-2B/U are similar in purpose, operation, and appearance. On some equipments, the FUNCTION switch and the FIL. CONT. SHORT lamp are marked LEAKAGE VR and SHORT, respectively. Other external differences among models of the tube tester are shown below.

Item	Tests sets, electron tube		
	TV-2/U	TV-2A/U	TV-2B/U
GM CENTERING control.	Dot index markings on knob and panel.	Line index markings on knob and panel.	Line index markings on knob and panel.
PLATE fine control ----	Round, fluted knob; dot index markings on knob and panel.	Pointer-type knob; line index marking on panel.	Pointer-type knob; line index marking on panel.
Test adapters -----	X13B used -----	X13B used -----	X3B, X7B, X10B, and X13B used.
Antiparasitic ferrite beads.	Not included -----	Not included -----	Included.
PERCENT QUALITY meter.	Interchangeable with TV-2A/U --	Interchangeable with TV-2/U ----	Not interchangeable with previous models.

CHAPTER 2

OPERATION

Section I. SERVICE UPON RECEIPT OF EQUIPMENT

8. Unpacking

a. **Packaging Data.** When packed for shipment, the tube tester is cushioned on all surfaces and placed within a water-resistant fiberboard box. The fiberboard box is sealed with water-resistant tape and placed within a wooden shipping box. Spare tubes, lamps, and fuses are placed in their designated positions within the tube tester (figs. 1 and 8). The technical manuals are packed within a close-fitting bag fabricated of waterproof wrapping paper. The bag is securely sealed with waterproof pressure-sensitive tape. The wooden shipping box is strapped only for intertheater shipment. A typical wooden shipping box and its contents are shown in figure 2.

- (1) The inside dimensions of a wooden shipping box that contains a tube tester is approximately $19\frac{1}{4}$ by $18\frac{1}{4}$ by $10\frac{3}{4}$ inches.
- (2) The outside volume of the tube tester packed in a wooden shipping box is 2.16 cubic feet, and weighs 60 pounds.

b. *Removing Contents.*

- (1) Cut and fold back the metal straps.
- (2) Remove the nails from the top with a nailpuller and remove the wooden top.
- (3) Do not attempt to pry off the top; prying may damage the equipment.
- (4) Remove the fiberboard box and cut through the three edges of the box and remove the contents.

9. Checking Unpacked Equipment

a. Check the equipment for any loss or damage that might have occurred during shipment. If the equipment has been damaged or is incomplete, refer to paragraph 2.

b. If the equipment has been used or reconditioned, see whether it has been changed by a Modification Work Order (MWO). If

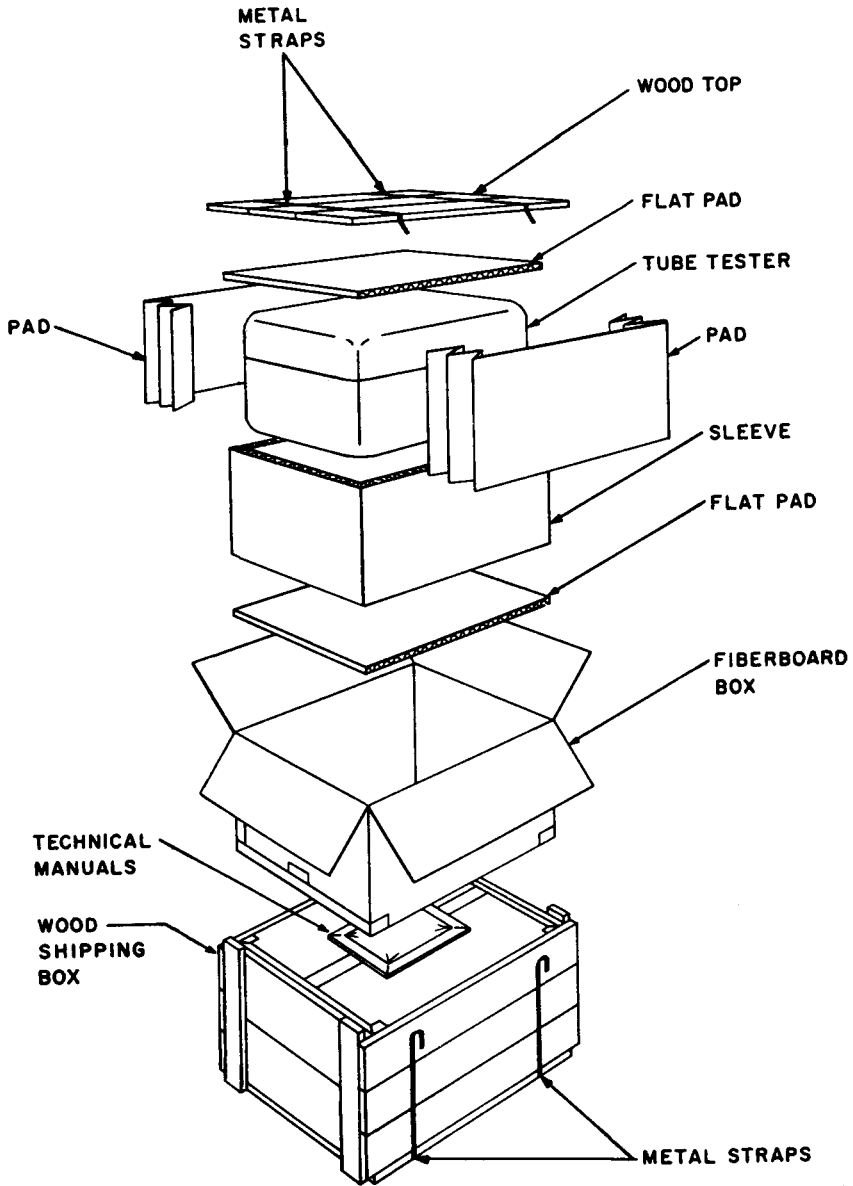

Figure 2. Typical packaging.

modified, the MWO number will appear on the front panel near the nomenclature plate.

c. Check the equipment against the packing list. When no packing list accompanies the equipment, use the table of components (par. 5a) and/or the basic issue items list (app. III) as a general check.

Section II. OPERATORS CONTROLS AND INDICATORS

10. Damage From Improper Settings

Improper setting of the FILAMENT RANGE switch (fig. 3) or incorrect operation of the PRESS TO TEST switches may damage the tube under test. Be sure that all the controls and switches are set properly before inserting the tube in the socket.

11. Operating Controls and indicators

(fig. 3)

a. Controls.

Control	Function								
ON-OFF switch	In ON position, applies ac power to unit.								
PRESS TO TEST (switches P1 through P6).	Depending on type of test selected, depressing one or more switches applies power to tube under test.								
SHORT TEST (6-position rotary switch).	In OPER. position, permits all tests except short test. By turning switch successively through positions V, W, X, Y, and Z, various tube electrodes are tested for interelement shorts.								
FUNCTION (3-position rotary switch). <i>Note.</i> On some equipment this switch is marked LEAKAGE VR.	<table style="width: 100%; border-collapse: collapse;"> <thead> <tr> <th style="text-align: left; width: 15%;"><i>Switch position</i></th> <th style="text-align: left;"><i>Action</i></th> </tr> </thead> <tbody> <tr> <td>TEST -----</td> <td>Permits all types of tube tests except voltage regulator and leakage tests.</td> </tr> <tr> <td>VR-----</td> <td>Permits tests of thyratrons and voltage regulator tubes in conjunction with PRESS TO TEST P5 switch.</td> </tr> <tr> <td>LEAK</td> <td>Permits determining interelement leakage in megohms as indicated by PLATE meter.</td> </tr> </tbody> </table>	<i>Switch position</i>	<i>Action</i>	TEST -----	Permits all types of tube tests except voltage regulator and leakage tests.	VR-----	Permits tests of thyratrons and voltage regulator tubes in conjunction with PRESS TO TEST P5 switch.	LEAK	Permits determining interelement leakage in megohms as indicated by PLATE meter.
<i>Switch position</i>	<i>Action</i>								
TEST -----	Permits all types of tube tests except voltage regulator and leakage tests.								
VR-----	Permits tests of thyratrons and voltage regulator tubes in conjunction with PRESS TO TEST P5 switch.								
LEAK	Permits determining interelement leakage in megohms as indicated by PLATE meter.								
Seven SELECTORS switches: FIL- and FIL+ 12-position rotary switches.	<p>Turning each of the filament switches to one of positions 1 to 9 connects filament voltage to correspondingly numbered base pin of tube under test. (0 is no connection.)</p> <p>Turning the switches to position A or B connects filament voltage to A or B electrical clip, respectively.</p>								
GRID (12-position rotary switch) -	<p>When set to one of positions 1 to 9, connects grid bias and signal voltage to correspondingly numbered base pin of tube under test. (0 is no connection.)</p> <p>In A or B, connects grid bias and signal voltage to A or B electrical clip.</p>								

Control	Function						
PLATE (12-position rotary switch).	When set to one of positions 1 to 9, connects plate voltage to correspondingly numbered base pin of tube under test. (0 is no connection.) In position A or B, connects plate voltage to A or B electrical clip.						
SCREEN (12-position rotary switch).	When set to one of positions 1 to 9, connects screen voltage to correspondingly numbered base pin of tube under test. (0 is no connection.) In position A or B, connects screen voltage to A or B electrical clip.						
CATHODE (12-position rotary switch).	When set to one of positions 1 to 9, connects desired test circuit to cathode of tube under test through correspondingly numbered base pin or, in position A or B, connects through A or B electrical clip.						
SUPPRESSOR (12-position rotary switch).	When set to one of positions 1 to 9, connects desired test circuit to suppressor grid of tube under test through correspondingly numbered base pin or, in position A or B, through A or B electrical clip.						
FILAMENT RANGE (20-position rotary switch).	Selects proper filament voltage between OFF (0-volt) and 117 (117 volts ac).						
FILAMENT fine control -----	Permits fine adjustment of filament voltage applied to tube under test.						
BIAS RANGE (8-position rotary switch).	Selects 5, 10, or 50 volts fixed bias, or connects biasing resistors as required when in positions A, B, C, D, or E.						
BIAS fine control -----	Permits fine adjustment of bias voltage.						
PLATE-SCREEN RANGE (12-position rotary switch).	When in positions G, H, J, K, M, N, P, Q, R, or S, connects the proper plate and screen grid voltage to be used in the test circuit. (OFF is no connection.)						
PLATE fine control-----	Permits fine adjustment of plate voltage.						
SCREEN fine control -----	Permits fine adjustment of screen grid voltage.						
GM-SIGNAL RANGE (6-position rotary switch).	<table border="0" style="width: 100%;"> <tr> <td style="text-align: center; vertical-align: bottom;"><i>Switch position</i></td> <td style="text-align: center; vertical-align: bottom;"><i>Action</i></td> </tr> <tr> <td>A through E--</td> <td>Connects proper ac signal voltage to grid of the tube under test.</td> </tr> <tr> <td>F-----</td> <td>Removes signal voltage from grid of tube under test to permit calibration of PERCENT QUALITY meter for</td> </tr> </table>	<i>Switch position</i>	<i>Action</i>	A through E--	Connects proper ac signal voltage to grid of the tube under test.	F-----	Removes signal voltage from grid of tube under test to permit calibration of PERCENT QUALITY meter for
<i>Switch position</i>	<i>Action</i>						
A through E--	Connects proper ac signal voltage to grid of the tube under test.						
F-----	Removes signal voltage from grid of tube under test to permit calibration of PERCENT QUALITY meter for						

Control	Function
	<p style="text-align: center;"><i>Switch position</i> <i>Action</i></p> <p style="text-align: center;">performance of transconductance (GM) test.</p>
SIGNAL-VR control-----	Permits accurate adjustment of ac signal level (indicated on the SIGNAL meter). In test of voltage-regulator tubes, permits adjustment of maximum and minimum currents through the tube (indicated on the PLATE meter).
Quality SHUNT control -----	When set to the position specified on the tube test data roll chart, shunts PERCENT QUALITY meter with proper resistance to perform quality (GM) test.
GM CENTERING control -----	With GM-SIGNAL RANGE switch in position F and the quality SHUNT control set in accordance with tube test data, permits zero calibration of the PERCENT QUALITY meter for transconductance (GM) test.

b. Indicators.

Indicator	Function
PERCENT QUALITY meter -----	Indicates transconductance of amplifier tube under test.
FILAMENT VOLTS meter -----	Indicates ac filament voltage supplied to tube under test.
GRID BIAS VOLTS meter -----	Indicates grid-bias voltage supplied to tube under test.
PLATE meter -----	Indicates plate voltage supplied to tube under test.
SCREEN VOLTS meter -----	Indicates screen grid voltage supplied to tube under test.
SIGNAL meter -----	Indicates ac signal level supplied to tube under test.
PILOT lamp -----	Glows when tube tester is connected to ac power source and power ON-OFF switch is in ON position.
FIL. CONT. SHORT lamp -----	Glows to indicate short-circuited elements or filament continuity in tube under test.
<p>Note. On some equipments this lamp is marked SHORT.</p>	

12. Tube Test Data

Tube test data in roll chart form is mounted in a case inside the cover of Test Set, Electron Tube TV-2(*)/U (fig. 1). The tube test data roll chart has left- and right-hand sections. The tube types appear in ascending numerical and alphabetical order from top to bottom in the left-hand section and from bottom to top in the right-hand section. Designations on the tube test data roll chart housing (fig. 4), which appear in duplicate over both sections of the tube test data roll chart, indicate the tube type, the switches and controls of the tube tester in the order in which settings should be made, and the minimum acceptable percentage of rated transconductance as indicated on the PERCENT QUALITY meter. The information necessary to set the switches and controls for any tube type listed on the tube test data roll chart appear directly below these column headings.

Column	Description
TUBE TYPE -----	Tubes that can be tested on the TV-2(*)/U are listed in numerical and alphabetical order.
TEST -----	Indicates type of test to be performed, as follows: EM-Emission ER-Electron-ray indicator GM-Transconductance LK-Leakage TH-Thyratron VR-Voltage regulator
FUNCTION-----	Indicates setting of FUNCTION switch, as follows: L-Leakage T-Test VR-Voltage regulator
SELECTORS (L TO R) -----	Indicates setting of each selector switch, reading from left to right on the tube tester, as follows: FIL - FIL + GRID PLATE SCREEN CATHODE SUPPRESSOR
RANGE -----	Indicates setting of range controls which correspond to following subcolumns: FILAMENT BIAS PL.-SCR GM.-SIG

Column	Description
METER SETTING -----	Indicates setting of meters, by adjusting associated fine controls, which correspond to the following subcolumns: PLATE BIAS SCREEN SIG-VR (set to redline (RL) or full scale (FS))
SHUNT -----	Indicates setting of SHUNT control.
PRESS TO TEST -----	Indicates which switch or switches, P1 through P6, should be pressed for the following tests: P1-Filament continuity and zeroing of PLATE ohmmeter for interelement leakage test. P2-Emission of diode tubes. P3-With P2 emission of multigrid tubes. P4-Transconductance. P5-Voltage regulator and thyratron tubes. P6-Gas test of amplifier tubes.
MIN LIM (left section) MINIMUM LIMITS (right section).	Indicates minimum numerical value as read on PERCENT QUALITY meter for tube under test or individual section of multipurpose tube under test.
N O T E S -----	Gives special information or adjustments pertaining to tube under test.

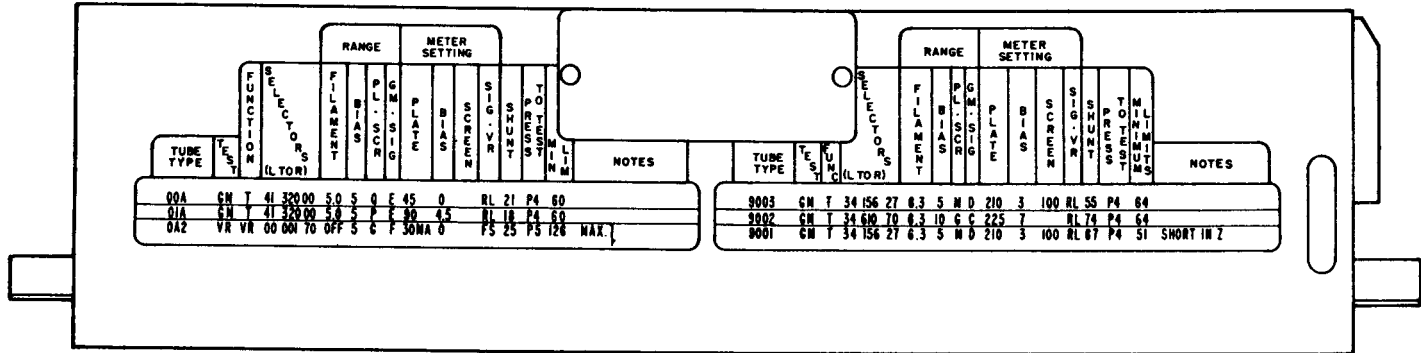

Figure 4. Tube test data roll chart, mounted in housing.

Section III. PRELIMINARY OPERATING PROCEDURES

13. Operating Precautions

(fig. 3)

a. Do not insert a tube into a test socket until the SELECTORS switches and the FILAMENT RANGE switch are properly adjusted (par. 16).

b. Return all controls to their safety positions (par. 15d) when the tube tester is turned off.

c. Do not prolong the testing of tubes with filaments that draw more than 3 amperes.

d. Inspect the bases of seven- and nine-pin miniature tubes for bent pins before inserting the tube into the test socket. If any pins are bent, straighten and align them by inserting the tube into the proper pin straightener (mounted on the inside of the cover of the tube tester (fig. 1)) and pressing the tube down firmly.

14. Tube Test Sockets and Test Adapters

After the controls on the tube tester have been set as directed in the tube test data roll chart (par. 12), place the tube to be tested in the proper tube test socket listed below.

a. *Tube Test Sockets* (fig. 3).

Tube test socket	Tube type tested
FOUR -----	Four-pin standard tubes.
FIVE -----	Five-pin standard tubes.
LOCTAL -----	Loctal base tubes.
SIX -----	Six-pin standard tubes.
MIN. SEVEN -----	Seven-pin miniature tubes.
SUB-MIN. EIGHT LONG LEAD_	Eight-pin, long-lead subminiature tubes.
TRANSMITTING SEVEN PIN-----	Seven-pin transmitting tubes.
NOVAL -----	Nine-pin miniature tubes.
OCTAL -----	Octal base tubes.
SEVEN -----	Seven-pin standard tubes.
ACORN -----	Acorn tubes.
SUB-MIN. SEVEN -----	Seven-pin subminiature tubes.
SUB-MIN. EIGHT -----	Eight-pin subminiature tubes.

b. *Test Adapters.* A test adapter X13B (fig. 1) is included to provide a test socket for eight-pin, subminiature, long lead tubes. Three test adapters (fig. 5) (X3B (eight-pin octal), X7B (nine-pin noval), and X10B (seven-pin miniature)) are included with each TV-2B/U. The test adapters are installed in their corre-

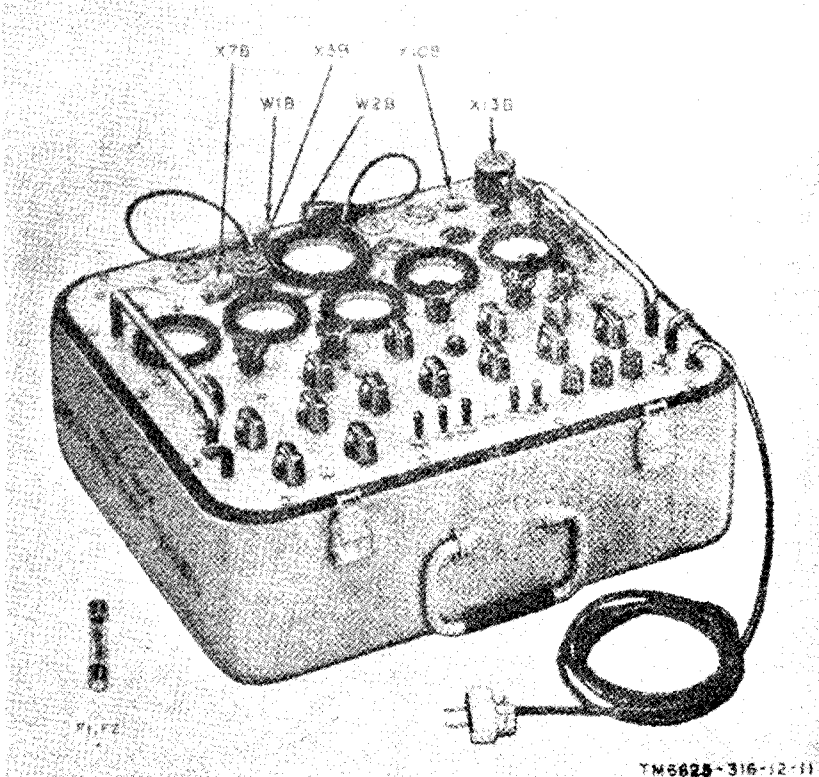

Figure 5. Panel of Test Set, Electron Tube TV-2B/U, showing location of test adapters (fuse also shown).

sponding sockets and receive the wear rather than the permanent socket. When worn so that satisfactory contact can no longer be made, the test adapters can be replaced without disconnecting the leads from their respective test socket.

15. Preliminary Starting Procedure

a. Check the voltage and frequency of the alternating current (ac) power source to be used for the operation of Test Set, Electron Tube TV-2(*)/U. The voltage must be between 103.5 and 126.5 volts ac and the frequency between 50 and 1,000 cycles per second (cps).

Cution: Never connect the TV-2(*)/U to a direct current (dc) power source.

- b. Release the latches and raise the cover of the tube tester.
- c. Remove the power cord plug from the dummy power cord

receptacle on the panel (fig. 1) and unwind the power cord from the brackets.

d. Check to see that all controls and switches are in their power cord safety positions as follows:

Switch or control	Safety position
ON-OFF -----	OFF.
SHORT TEST -----	OPER.
FUNCTION -----	TEST.
PRESS TO TEST P1, P2, P3, P4, P5, and P6.	Neutral
FIL and FIL+ -----	0.
GRID -----	0.
PLATE -----	0.
SCREEN -----	0.
CATHODE -----	0.
SUPPRESSOR -----	0.
FILAMENT RANGE -----	OFF.
FILAMENT fine control -----	Extreme counterclockwise.
BIAS RANGE -----	50.
BIAS fine control -----	Extreme counterclockwise.
PLATE-SCREEN RANGE -----	OFF.
PLATE fine control -----	Extreme counterclockwise.
SCREEN fine control -----	Extreme counterclockwise.
SIGNAL-VR fine control -----	Extreme counterclockwise.
GM-SIGNAL RANGE -----	F.
SHUNT control -----	0.
GM CENTERING control -----	Midposition (as shown by alinement of dot on knob with that on panel).

e. Condensed operating instructions are mounted inside the cover of the tube tester (fig. 1). Revise the condensed operating instructions for GM TESTING to read as follows:

- (1) Perform all operations listed in I through IV.
- (2) Depress P4 and reset controls as shown on tube test data roll chart.
- (3) Release P4, set GM-SIGNAL RANGE control to F, and depress P4.
- (4) Set PERCENT QUALITY meter to 0 with GM CENTERING control.
- (5) Release P4 and return GM-SIGNAL RANGE control to tube test data roll chart listing.
- (6) Depress P4; if PERCENT QUALITY meter reading is above value in MIN LIM column, tube is good. Release P4.

f. Insert the power cord plug into the ac outlet.

Section IV. OPERATION UNDER USUAL CONDITIONS

16. Starting Procedure

Note. To start the equipment, first make sure the controls are set as required by the preliminary starting procedure (par. 15) and then perform procedures described in *a* through *i* below.

a. Locate the type number of the tube to be tested on the tube test data roll chart mounted inside the cover of the tube tester.

b. Set the seven SELECTORS switches to the positions given on the tube test data roll chart for the tube under test. Set the switches in the order in which they appear on the tube test data roll chart and on the tube tester panel, from left to right, starting with the FIL-SELECTORS switch on the left-hand side.

Note. The seven SELECTORS switches are interconnected electrically so that two different voltages cannot be applied to the same pin of the tube under test at the same time. Thus, by setting the SELECTORS switches in the order in which the switches are arranged on the panel, short circuits are avoided.

c. Set the FILAMENT RANGE switch to the position indicated on the tube test data roll chart.

d. Insert the tube to be tested into the proper test socket.

***Caution:* Be careful when inserting and removing octal, acorn, and subminiature tubes from their sockets. Excessive force will crack the glass seals at the bases of the pins. Exert slight pressure to one side to release the lock of the LOCTAL socket. Use the pin straighteners mounted on the tube test data roll chart housing to straighten bent pins of seven- and nine-pin miniature tubes.**

e. If the tube to be tested has a top cap, attach the A or B electrical clip. Directions as to which clip to use are given in the NOTES column on the tube test data roll chart unless the NOTES column is required for other data. In addition, one of the SELECTORS switches will indicate an A or B position. If the A position is designated, use the A clip; if the B position is designated, use the B clip.

f. Set the ON-OFF switch to the ON position. The PILOT lamp should glow. Allow at least 1 minute warmup time.

g. Adjust the FILAMENT fine control until the FILAMENT VOLTS meter pointer indicates the exact filament voltages specified in the RANGE column of the tube test data roll chart unless there is a note to the contrary. In the case of a filament voltage of 0.625, 6.3, 12.6, or 117 volts, adjust the control until the meter pointer is on the red calibration line on the appropriate scale.

h. If the line voltage is low, it may not be possible to adjust the FILAMENT fine control to indicate the specified filament voltage. When this condition exists, turn the FILAMENT

RANGE switch to the next higher position, and then adjust the control until the correct voltage is indicated on the meter.

i. If the line voltage is high and it is not possible to adjust the FILAMENT fine control to indicate the specified voltage, turn the FILAMENT RANGE switch to the next lower position, and then adjust the control until the correct voltage is indicated on the meter.

17. Zero Adjustment of PERCENT QUALITY Meter

When the procedures in paragraph 16 have been completed, adjust the PERCENT QUALITY meter to zero. This adjustment should be made before testing any tube for transconductance (GM) as follows:

- a.* Turn the GM-SIGNAL RANGE switch to the F position.
- b.* Depress the PRESS TO TEST P4 switch to its locking position. Reset the controls to give the exact meter readings specified in the METER SETTING columns of the tube test data roll chart.
- c.* Adjust the GM CENTERING control until the pointer of the PERCENT QUALITY meter is set exactly to zero on the scale.
- d.* Release the P4 switch.

18. Short Test

- a.* Perform the operations described in paragraphs 15 and 16.
- b.* For the TV-2/U, aline the dot on the PLATE fine control with the dot on the panel. For TV-2A/U and TV-2B/U, aline the PLATE fine control pointer-type knob with the line index marking on the panel. This assures that the correct voltage will be applied to the short test circuit.
- c.* Turn the SHORT TEST switch slowly from the OPER. position to V, W, X, Y, and Z, and back to OPER.; at the same time, tap the tube with a *finger* and watch the FIL. CONT. SHORT indicator lamp.

Caution: Do not tap the tubes listed below when testing for short-circuited elements. Tapping may damage the tube.

1A5GT	1LH4
1A7GT	1LN5
1C5GT	1P5GT
1G4GT	1Q5QT
1G6GT	1S4
1H5GT	1S5
1L4	1T4
1LA4	1T5GT
1LA6	1U4
1LB4	1U5
1LD5	3A4
1LE3	3A5

3A6GT
3B7
3D6
3LF4

3Q4
3Q5QT
3S4
3V4

d. If the lamp burns continuously or glows during tapping in any one of the five positions of the SHORT TEST switch, the tube contains short-circuited electrodes. Discard the tube unless an exception is noted on the tube test data roll chart.

e. Disregard a momentary flash of the FIL. CONT. SHORT indicator lamp while the SHORT TEST switch is being moved from one position to the next. This flashing usually is caused by the charging of a capacitor in the test circuit.

Note. Some tubes *normally* test as shorted when the SHORT TEST switch is in certain positions. Before discarding a tube that shows a short, check the tube test data roll chart NOTES column for information on normal short indications.

f. When the test is completed, set the ON-OFF switch to the OFF position, remove the tube under test from the test socket, and return all switches and controls to their safety positions (par. 15d) .

19. Interelement Leakage Test

Follow the test procedure in *a* through *e* below to determine the interelement leakage (LK) in megohms between electrodes of the tube under test.

a. Perform the operations described in paragraphs 15 and 16.

b. Operate the FUNCTION switch to the LEAK position. This position connects the PLATE meter into the circuit to serve as an ohmmeter for this test only.

c. Set the ohmmeter (PLATE meter) to zero as follows:

- (1) Operate the SHORT TEST switch to the V position.
- (2) Turn the PLATE fine control to its maximum counter-clockwise position.
- (3) Depress the PRESS TO TEST P1 switch.
- (4) With the P1 switch held in its depressed position, adjust the PLATE fine control until the pointer of the PLATE meter indicates zero (250 on center scale) on the ohmmeter (top) scale.
- (5) Release the P1 switch.

d. Operate the SHORT TEST switch slowly from the OPER. position to positions V, W, X, Y, and Z; at the same time, watch for a deflection of the PLATE meter pointer.

- (1) An open circuit or infinite leakage between elements will produce no deflection of the PLATE meter pointer.
- (2) A short circuit between two elements will produce a full-scale deflection of the PLATE meter pointer.

Note. Where the NOTES column indicates a short circuit, full-scale deflection will appear at those settings.

- (3) Read intermediate leakage values on the resistance scale of the PLATE meter. The amount of leakage is indicated in megohms.

e. When the test is completed, set the ON-OFF switch to the OFF position, remove the tube under test from the test socket, and return all switches and controls to their safety positions (par. 15d) .

20. Filament Continuity Test

a. Perform the operations in paragraphs 15 and 16.

b. If the filament continuity test is the only test to be made, set only the FIL- and the FIL+ SELECTORS switches as indicated in the tube test data roll chart. Leave the remaining SELECTORS switches in their safety positions (par. 15d).

c. Operate the SHORT TEST switch to the V position. For the TV-2/U, aline the dot on the PLATE fine control with the dot on the panel. For the TV-2A/U, and TV-2B/U, aline the line marking on the PLATE fine control with the line marking on the panel.

d. Depress the PRESS TO TEST P1 switch.

- (1) If the FIL. CONT. SHORT lamp glows, the filament is good.
- (2) If the FIL. CONT. SHORT lamp does not glow, the filament is open. Discard the tube.

Note. Occasionally a filament will show continuity when cold, but will open when it warms up. If this condition is suspected, set the FILAMENT RANGE switch to the normal voltage for the tube under test, let the tube warm up for several minutes, and repeat the test.

21. Transconductance Test

a. Perform the operations described in paragraphs 15 and 16.

b. Operate the FUNCTION switch to the TEST position.

c. Operate the PLATE-SCREEN RANGE switch to the position specified on the tube test data roll chart.

Warning: Do not touch the top cap of a tube under test after plate voltage has been applied.

d. Adjust the PLATE and SCREEN fine controls until the PLATE and SCREEN VOLTS meters indicate the exact voltages specified on the tube test data roll chart. Red calibration marks on both meters facilitate this adjustment.

e. Set the BIAS RANGE switch to the voltage or position specified on the tube test data roll chart.

f. Adjust the BIAS fine control until the GRID BIAS VOLTS meter indicates the exact grid-bias voltage specified on the chart.

g. If the bias voltage indication is over 80 percent of full scale at a low plate voltage setting, it may be difficult to obtain the required bias voltage. In such a case, use the next higher setting of the BIAS RANGE switch.

h. Operate the quality SHUNT control to the number given on the tube test data roll chart.

i. Adjust the PERCENT QUALITY meter to zero (par. 17).

j. Operate the GM-SIGNAL RANGE switch to the position specified for the quality test.

k. Adjust the SIGNAL-V.R. fine control until the pointer of the SIGNAL meter is on the red line.

l. Depress the PRESS TO TEST P4 switch to its locking position.

m. Read the percent quality for the tube under test on the PERCENT QUALITY meter.

- (1) If the reading is below the minimum limit indicated on the tube test data roll chart, discard the tube.
- (2) If the reading borders on the minimum limit, the tube may be usable but should be replaced soon.
- (3) If the PERCENT QUALITY meter indication is beyond full scale, the tube may be gassy. Perform the gas test (par. 22).

n. Release the P4 switch.

Note. A multisection tube may be listed several times on the tube test data roll chart. If this is the case, reset the SELECTORS switches for each listing in the tube test data roll chart. Repeat the short test and the trans-conductance test for each new setting.

o. When a test is completed, set the ON-OFF switch to the OFF position, remove the tube under test from the test socket, and return all switches and controls to their safety positions (par. 15d) .

22. Gas Test

Use the following procedures to determine whether an amplifier

tube contains excessive gas. When testing a multisection tube, make the gas test on an amplifier section; it does not apply to diode sections or to rectifiers.

a. Perform the operations in paragraphs 15 and 16.

b. Operate the FUNCTION switch to the TEST position.

c. Operate the PLATE-SCREEN RANGE switch to the position specified on the tube test data roll chart.

Warning: Do not touch the top cap of a tube under test after plate voltage has been applied.

d. Adjust the PLATE and SCREEN fine controls until the PLATE and SCREEN VOLTS meters indicate the exact voltages specified on the tube test data roll chart. Red calibration marks on the scales of both meters facilitate this adjustment.

e. Operate the BIAS RANGE switch to the voltage or position specified on the tube test data roll chart.

f. Adjust the BIAS fine control until the GRID BIAS VOLTS meter indicates the specified voltage.

g. Set the quality SHUNT control to the number given on the tube test data roll chart, and adjust the PERCENT QUALITY meter to zero (par. 17).

h. Operate the GM-SIGNAL RANGE switch to the position specified for the quality test.

i. Adjust the SIGNAL-V.R. fine control until the pointer of the SIGNAL VOLTS meter is on the red line.

j. Depress the PRESS TO TEST P4 switch to its locking position.

k. Depress and hold down the PRESS TO TEST P6 switch. Depressing the P6 switch may cause the PERCENT QUALITY meter pointer to move upward or downward on the scale. If the pointer moves more than three scale divisions in either direction, the tube contains too much gas for satisfactory operation.

Note. Some tubes develop gas after they have been in operation for a period of time. When this is suspected to be the case, let the tube remain under test with operating potentials applied for several minutes before making the gas test.

l. When the test is completed, set the ON-OFF switch to the OFF position, remove the tube under test from the test socket, and return all switches and controls to their safety positions (par. 15d).

23. Emission Test

Use the following procedure to test the emission (EM) of rectifier tubes, diode detectors, and multielement tubes.

- a. Perform the operations described in paragraphs 15 and 16.
- b. Operate the FUNCTION switch to the TEST position.
- c. Set the PLATE-SCREEN RANGE switch to the position specified on the tube test data roll chart.
- d. Adjust the PLATE fine control until the PLATE meter indicates the exact voltage specified on the tube test data roll chart. Red calibration marks on the meter scales facilitate this adjustment.
- e. Operate the quality SHUNT control to the number specified on the tube test data roll chart.
- f. Operate the GM-SIGNAL RANGE switch to the position noted on the tube test data roll chart.
- g. For the TV-2/U, align the dot on the knob of the GM CENTERING control with the dot on the panel. For the TV-2A/U and TV-213/U, align the line marking on the GM CENTERING knob with the line marking on the panel.
- h. If the tube under test is a diode, hold down the PRESS TO TEST P2 switch. If the tube under test is a multigrid tube, hold down *both* the P2 and P3 switches.
- i. Read the PERCENT QUALITY meter. If the indication is below the minimum limit given on the tube test data roll chart, discard the tube. Tubes that border on the minimum limit may be usable but should be replaced soon.

Note. When testing some diodes, the PERCENT QUALITY meter will deflect off scale. This is a normal condition when the emission of the tube is far in excess of that required by tube specifications. If the need for balancing such a diode is present, reduce the setting of the quality SHUNT control until the PERCENT QUALITY meter reads 100. Observe the new shunt setting and use this setting to compare diodes of the same type.
- j. When the test is completed, set the ON-OFF switch to the OFF position, remove the tube under test from the test socket, and return all switches and controls to their safety positions (par. 15d).

24. Voltage Regulator and Gas Rectifier Test

Use the following procedure to test the voltage regulator (VR) and gas rectifier tubes under minimum and maximum load conditions. The regulating ability of the tube is computed from the test results. For testing thyratron tubes, refer to paragraph 26.

- a. Perform the operations described in paragraphs 15 and 16. Set the FILAMENT RANGE and BIAS RANGE switches to the positions indicated in the tube test data roll chart.
- b. Set the PLATE-SCREEN RANGE switch to the position specified on the tube test data roll chart.

c. Set the quality SHUNT control to the number specified on the tube test data roll chart.

d. Set the FUNCTION switch to the VR position.

e. Turn the SIGNAL-V.R. and the BIAS fine controls to their extreme counterclockwise (zero) positions.

f. Depress and hold down the PRESS TO TEST P5 switch. Note the current through the tube as indicated on the PLATE meter and note the reading of the PERCENT QUALITY meter.

g. With the P5 switch held in its operated position, adjust the SIGNAL-V. R., PLATE, and SCREEN fine controls until the VR-50 MA scale of the PLATE meter indicates the minimum load current through the tube as specified on the tube test data roll chart. Note the reading of the PERCENT QUALITY meter.

h. With the PRESS TO TEST P5 switch still held in its operated position, adjust the SIGNAL-V.R. fine control until the VR-50 MA scale of the PLATE meter indicates the maximum load current specified on the chart. Note the reading of the PERCENT QUALITY meter.

i. Determine the regulating ability of a tube by taking the difference between the maximum and minimum load currents through the tube as read on the PERCENT QUALITY meter. If the difference between the two readings is greater than the maximum difference indicated on the tube test data roll chart, discard the tube.

Note. A quality SHUNT control setting of 50 is specified for many voltage regulator tubes. When so specified, the reading on the PERCENT QUALITY meter indicates directly the voltage drop across the tube under test. The difference between the voltage drop at minimum and maximum load currents as read on the PERCENT QUALITY meter then is equal to the regulating ability of the tube in *volts*.

j. When the test is completed, set the ON-OFF power switch to the OFF position, remove the tube under test from the test socket, and return all switches and controls to their safety positions (par. 15d).

25. Procedure for Reading Plate Current (Less Than 50 Milliamperes) of Triode Tubes

a. Perform the operations indicated in paragraphs 15 and 16.

b. Set all SELECTORS switches as indicated on the tube test data roll chart with the exception of the PLATE and SCREEN SELECTORS switches.

c. Set the PLATE selector switch to the 0 position.

d. Set the SCREEN SELECTORS switch to the position desig-

ated for the PLATE SELECTORS switch on the tube test data roll chart.

e. Set the GM-SIGNAL RANGE switch to the F position.

f. Adjust the SCREEN fine control until the voltage specified on the tube test data roll chart for the PLATE meter is indicated on the SCREEN VOLTS meter.

Note. It may be necessary to set the PLATE-SCREEN RANGE switch to a new setting, moving the switch in a counterclockwise direction, so that the SCREEN VOLTS meter can indicate the voltage specified for the PLATE meter.

g. Adjust all other fine controls as required on the tube test data roll chart for the tube under test.

h. Turn the SIGNAL-V.R. fine control to its maximum counterclockwise position.

i. Set the FUNCTION switch to the VR position.

j. Set the quality SHUNT control to 0.

k. Depress the PRESS TO TEST P5 switch. Be sure the proper voltages for the tube being tested appear on all other meters. Note the reading on the 0- to 50-milliamper (ma) scale on the PLATE meter.

l. Release the PRESS TO TEST P5 switch.

m. When the test is completed, set the ON-OFF power switch to the OFF position, remove the tube under test from the test socket, and return all switches and controls to their safety positions (par. 15d).

26. Thyatron Test

Use the following procedure to determine the *firing potential* of thyatron (TH) tubes. Thyatrons are also called gas triodes or grid glow tubes. The firing potential may be defined as the grid voltage at which the tube begins to conduct.

a. Perform the operations indicated in paragraphs 15 and 18.

b. Set the FUNCTION switch to the VR position.

c. Set the PLATE-SCREEN RANGE switch to the position specified on the tube test data roll chart.

d. Set the quality SHUNT control to the number specified on the tube test data roll chart.

e. Set the SIGNAL-V.R. fine control to its extreme clockwise (maximum) position.

f. Depress and hold down the PRESS TO TEST P5 switch. Note the current through the tube as indicated on the PLATE meter, and note the reading of the PERCENT QUALITY meter.

g. Adjust the SCREEN fine control until the SCREEN VOLTS meter indicates the voltage specified on the tube test data roll chart (par. 12).

h. Set the BIAS fine control to its extreme clockwise (maximum) position.

i. With the PRESS TO TEST P5 switch held in its operated position, gradually reduce the bias voltage by adjusting the BIAS fine control until the tube strikes its firing potential. The firing potential is indicated by a sudden increase in load current shown on the PLATE meter and by a sudden decrease on the PERCENT QUALITY meter.

Note. The tube will not conduct (as indicated by an increase in load current shown by the PLATE meter) until the critical grid-bias voltage is reached. For example, for a type 2D21W or type 2050W tube, the bias voltage at which conduction occurs should be between 1.5 and 3.0 volts.

j. The voltage at which the tube strikes is read on the GRID BIAS VOLTS meter. Record the grid voltage at the instant and at the point that the pointer starts to deflect. This is the striking voltage of the tube under test. Repeat the test to confirm the reading. Minimum limits for striking voltages of thyratrons are given on the tube test data roll chart.

k. When the test is completed, set the ON-OFF power switch to the OFF position, remove the tube under test from the test socket, and return all switches and controls to their safety positions (par. 15d).

27. Electron-Ray Indicator Test

There are two types of electron-ray (ER) indicator tubes that can be tested with the TV-2(*)/U, Type 6U5 and similar tubes have a triode section and a single indicator (one shadow). Type 6AF6 and similar tubes have no triode section, but have twin indicators (dual shadow). Follow the procedure below to check the opening and closing action of the eyes only. Indicators with triode sections also must be tested for emission (*i* below).

a. Perform the operations indicated in paragraphs 15 and 16.

b. Operate the FUNCTION switch to the TEST position.

c. Operate the PLATE-SCREEN RANGE switch to the position specified on the tube test data roll chart.

d. Adjust the PLATE and SCREEN fine controls until the exact voltages specified on the tube test data roll chart are indicated on the corresponding meters.

e. Depress the PRESS TO TEST P4 switch. If the tube is a single indicator, the indicator should be closed; if the tube is a twin-indicator tube, such as the 6AD6 or 6AF6, indicator No. 1 should be closed and indicator No. 2 should be open.

- f.* Release the PRESS TO TEST P4 switch.
- g.* For twin-indicator tubes, operate the SCREEN and SUPPRESSOR SELECTORS switches to the positions specified in the second line of the tube test data roll chart.
- h.* Again depress the PRESS TO TEST P4 switch. If the tube is good, the indicator now should be open, or, in the case of twin-indicator tubes, indicator No. 1 should be open and indicator No. 2 should be closed.
- i.* Perform an emission test on the triode of electron-ray indicators with triode sections, such as 6U5 (par. 23). The control settings for the emission test are specified in the third entry of the same tube on the tube test data roll chart (par. 12).

28. Ballast Tube Test

Test ballast tubes as follows:

- a.* Perform the operations indicated in paragraph 15.
- b.* Operate the FIL-SELECTORS switch to the position specified in the tube test data roll chart for the tube under test. All other switches and controls should be in their safety positions (par. 15d).
- c.* Insert the ballast tube into the appropriate socket.
- d.* Turn the ON-OFF power switch to the ON position.
- e.* Turn the SHORT TEST switch to the V position.
- f.* Depress and hold down the PRESS TO TEST P1 switch. Operate the FIL+ SELECTORS switch to each of the positions specified in the tube test data roll chart. The FIL.-CONT. SHORT lamp should glow in every position noted. If it does not, discard the ballast tube.
- g.* Repeat the procedures indicated in *b* through *f* above for each listing of the tube.

29. Indicator Lamp Test

To check an indicator lamp or other lamps with miniature bayonet or screw-type bases, proceed as follows:

- a.* OPERATE THE FIL- SELECTORS switch to position 2.
- b.* Operate the FIL+ SELECTORS switch to position 7.
- c.* Operate the FILAMENT RANGE switch to the correct voltage for the lamp under test. This voltage usually is marked on the lamp base.
- d.* Operate the ON-OFF power switch to the ON position.
- e.* Adjust the FILAMENT fine control until the FILAMENT VOLTS meter indicates the exact voltage specified for the lamp.

f. Insert and hold the lamp in the center of the SEVEN socket. If the lamp is good, it will light with normal brilliancy.

Caution: Do not test glow lamps with the TV-2(*)/U unless these lamps are supplied with a current-limiting series resistor.

g. When the test is completed, operate the ON-OFF power switch to the OFF position and return the FIL- and FIL+ SELECTORS switches, the FILAMENT RANGE switch, and the FILAMENT fine control to their safety positions (par. 15d).

30. Complete Tube Test

As an example of a complete tube test, assume a 6SQ7 tube is to be tested. The 6SQ7 tube is a twin-diode high-mu triode used as a combined detector, amplifier, and automatic voltage control tube in radio receivers. It has an eight-pin octal base. Rotate the tube test data roll chart until the 6SQ7 appears in the TUBE TYPE column in the left-hand window of the tube test data roll chart housing. In addition to tests for short circuits, interelement leakage, and filament continuity, note that this tube must be tested *three* times: to test the transconductance of the triode section, to measure the emission of diode No. 1, and to measure the emission of diode No. 2. In addition, the gas content of the tube must be checked.

a. *Preparation.* Adjust the tube test data roll chart so the first line on which 6SQ7 appears is in the center of the window between the horizontal red lines. Refer to the column headings marked on the tube test data roll chart housing and proceed as follows:

- (1) Perform the operations described in paragraph 15.
- (2) Set the FUNCTION switch to TEST (T).
- (3) Set the SELECTORS switches to the positions indicated in the SELECTORS (L TO R) column on the tube test data roll chart and in the order indicated:
 - (a) FIL— to 7.
 - (b) FIL+ to 8.
 - (c) GRID to 2.
 - (d) PLATE to 6.
 - (e) SCREEN to 0.
 - (f) CATHODE to 3.
 - (g) SUPPRESSOR to 0.
- (4) Set the FILAMENT RANGE switch to the 6.3 position.
- (5) Insert the 6SQ7 tube into the OCTAL test socket.
- (6) Set the ON-OFF switch to the ON position and allow a 1-minute warmup.

- (7) Adjust the FILAMENT fine control until the FILAMENT VOLTS meter needle indicates 6.3 volts.

b. Short Test. To perform the short test (par. 18) on the 6SQ7 tube, proceed as follows:

- (1) For the TV-2/U, align the dot on the PLATE fine control with the dot on the panel. For the TV-2A/U and TV-2B/U, align the PLATE fine control pointer-type knob with the line index marking on the panel.
- (2) Turn the SHORT TEST switch slowly from the OPER. position to V, W, X, Y, and Z, and back to OPER.; at the same time, tap the tube with a finger and watch the FIL. CONT. SHORT indicator lamp.
- (3) If the lamp glows continuously or glows during tapping in any of the five positions of the SHORT TEST switch, the tube contains a short circuit. Discard the tube. If there is no short circuit, proceed with the next test.

c. Interelement Leakage Test. To perform the test for interelement leakage (par. 19) on the 6SQ7 tube, proceed as follows:

- (1) Set the FUNCTION switch to the LEAK position.
- (2) Set the PLATE meter, which is functioning as an ohmmeter for this test, to zero (par. 19c).
- (3) Turn the SHORT TEST switch slowly from the OPER. position to V, W, X, Y, and Z; at the same time watch for a deflection of the PLATE meter pointer.
- (4) An open circuit or zero leakage between elements will produce no deflection of the PLATE meter pointer. A short circuit between elements will produce a full-scale deflection of the pointer. Read intermediate values on the resistance scale of the PLATE meter. If there is no leakage, proceed with the next test.
- (5) Set the FUNCTION switch to the TEST position.

d. Filament Continuity Test. Proceed as outlined below to determine whether the filament of the 6SQ7 tube is open (par. 20). The FIL- and FIL+ SELECTORS switches are set as indicated in the tube test data roll chart, at 7 and 8, respectively.

- (1) Set the SHORT TEST switch to the V position.
- (2) Depress the PRESS TO TEST P1 switch.
- (3) If the FIL. CONT. SHORT lamp glows, the filament is good. If the lamp does not glow, the filament is open. Discard the tube. If the filament is good, however, proceed to test the transconductance of the triode section.
- (4) Set the SHORT TEST switch to OPER.

e. Measurement of Transconductance. To test the transconductance of the triode section of the 6SQ7 tube, proceed as outlined below. The FUNCTION switch and all SELECTORS switches are set as in a (2) through (7) above.

- (1) Set the PLATE-SCREEN RANGE switch to the J position.
- (2) Adjust the PLATE fine control until the PLATE meter indicates 225 volts.
- (3) Set the BIAS RANGE switch to the 5 position.
- (4) Adjust the BIAS fine control until the GRID BIAS VOLTS meter indicates 2 volts.
- (5) Turn the SHUNT control to 90.
- (6) Adjust the PERCENT QUALITY meter to zero (par. 17).
- (7) Set the GM-SIGNAL RANGE switch to D.
- (8) Adjust the SIGNAL-V.R. control until the SIGNAL meter pointer is on the red line.
- (9) Depress the PRESS TO TEST P2 switch to its locking position. Read the percent quality of the 6SQ7 tube on the PERCENT QUALITY meter. If the reading is below the minimum limit of 25, discard the tube; if it borders on 25, the tube may be used but should be replaced soon. If the meter pointer is beyond full scale, test the tube for gas.

f. Test for Excessive Gas. To test the tube for gas, proceed as outlined below. The FUNCTION switch and all SELECTORS switches and range switches are set as in e above, and the FILAMENT VOLTS meter indicates 6.3 volts.

- (1) Depress the PRESS TO TEST P2 switch to its locking position.
- (2) Depress and hold down the PRESS TO TEST P6 switch. If the pointer of the PERCENT QUALITY meter remains at 25 or near 25, the tube does not contain excessive gas. If the pointer moves more than three scale divisions in either direction, however, the tube contains too much gas for satisfactory operation.

g. Measurement of Emission (Diode No. 1). To measure the emission of diode No. 1, adjust the tube test data roll chart so the second line on which the 6SQ7 tube appears is between the horizontal red lines. The FUNCTION switch, all SELECTORS switches except the PLATE switch, and the PLATE-SCREEN

RANGE switch are set as in a(2) through (4) above, and the FILAMENT VOLTS meter indicates 6.3 volts,

- (1) Set the PLATE switch to the 5 position.
- (2) Set the PLATE-SCREEN RANGE switch to the S position.
- (3) Adjust the PLATE fine control until the PLATE meter indicates 20 volts ac.
- (4) Turn the quality SHUNT control to 90.
- (5) Set the GM-SIGNAL RANGE switch to the A position.
- (6) For the TV-2/U, align the dot on the knob of the GM CENTERING control with the dot on the panel. For the TV-2A/U and TV-2B/U, align the line marking on the GM CENTERING control with the line marking on the panel.
- (7) Depress the PRESS TO TEST P2 switch and read the PERCENT QUALITY meter. If the indication is less than the minimum limit of 25, discard the tube. If the indication is satisfactory, measure the emission of diode No. 2.

h. Measurement of Emission (Diode No. 2). To measure the emission of diode No. 2, adjust the tube test data roll chart so the third line on which the 6SQ7 tube appears is between the horizontal red lines. The FUNCTION switch, all SELECTORS switches except the PLATE switch are set as in *g* above, and the FILAMENT VOLTS meter indicates 6.3 volts.

- (1) Set the PLATE switch to the 4 position.
- (2) With the PLATE-SCREEN RANGE switch on S, adjust the PLATE fine control until the PLATE meter indicates 20 volts ac.
- (3) The quality SHUNT control remains on 90.
- (4) The GM-SIGNAL RANGE switch remains on S.
- (5) For the TV-2/U, align the dot on the knob of the GM CENTERING control with the dot on the panel. For the TV-2A/U and TV-2B/U, align the line marking on the GM CENTERING control with the line marking on the panel.
- (6) Depress the PRESS TO TEST P2 switch and read the PERCENT QUALITY meter. If the indication is less than the minimum of 25, discard the tube. If the indication is satisfactory, the tube is good.

31. Stopping Procedure

- a.* Set the ON-OFF switch to the OFF position.
- b.* Remove the tube from the test socket.
- c.* Return all controls to their safety positions (par. 15d).
- d.* Remove the power cord from the power source, wind the power cord around the brackets on the panel, and insert the plug into the dummy power cord receptacle (fig. 1). Close the cover of the case, and latch the luggage-type fasteners.

CHAPTER 3
OPERATOR'S MAINTENANCE

32. General

The following is a list of maintenance duties normally performed by the operator of Test Set, Electron Tube TV-2(*)/U. These procedures do not require special tools or test equipment.

- a. Preventive maintenance (par. 33).
- b. Visual inspection (par. 34).
- c. Operational check (par. 35b).
- d. Replacement of defective lamps (par. 39b).
- e. Replacement of defective fuses (par. 39a).
- f. Checking cable connection.
- g. Replacement of defective electron tubes (pars. 36 and 37).

33. Preventive Maintenance

a. *DA Form 11-266.* DA Form 11-266 (figs. 6 and 7) is a preventive maintenance checklist to be used by the operator. Items not applicable to the tube tester are lined out in figure 7. References in the ITEM block in figure 7 are to paragraphs that contain additional maintenance information pertinent to the particular item. Instructions for the use of the form appear on the form.

b. *Items.* The information shown below supplements DA Form 11-266. The item numbers correspond to the ITEM numbers on the form.

Item	Maintenance procedures
1	Use a clean cloth to remove dust, dirt, moisture, and grease from the case and front panel. If necessary, wet the cloth with Cleaning Compound (Federal stock No. 7930-395-9542) and then wipe the parts with a dry, clean cloth.
3	All control knobs should work smoothly, be tight on the shafts, and should not bind. Tighten all loose knobs and be sure that the knobs do not rub against the panel.
5	Repair any cuts in the power cord insulation by covering them with rubber tape and then with friction tape.

Warning: Cleaning compound is flammable and its fumes are toxic. Do not use near a flame; provide adequate ventilation.

34. Visual Inspection

a. When the equipment fails to perform properly, turn off the power and check for the conditions listed below. *Do not check any item with the power on.*

- (1) Worn, broken, or disconnected power cord or connector.
- (2) Improperly connected electrical clips.
- (3) Burned-out or improperly seated fuses.
- (4) Defective or loose switch knobs. Operate the switches to be sure there is a definite stop at each position indicated on the panel.
- (5) Loose control knobs. Check the knobs by hand.
- (6) Improperly seated indicator lamps.

b. If the above checks do not locate the trouble, proceed to the operational checklist (par. 35).

35. Operational Checklist

a. General. The operational checklist provides a procedure for systematically checking equipment performance. All corrective measures that the operator can perform are given in the *Corrective measures* column. When using the checklist, start at step 1 and follow each step in order. If the corrective measures indicated do not repair the equipment, troubleshooting is required by higher echelon. Note on the repair tag how the equipment performed and the corrective measures taken. Perform the steps in *b* below.

b. Operational Checklist.

Action	Normal indication	Corrective measure
Set the ON-OFF switch to ON -----	PILOT lamp lights -----	Replace PILOT lamp (par. 39b). Replace fuses F1 and F2 (par. 39a). Higher echelon repair required.
Set FILAMENT RANGE switch to several voltages and adjust FILAMENT fine control for each of the voltages selected. Set GM-SIGNAL RANGE switch to each position and adjust SIGNAL-V.R. fine control for each position.	Pointer of FILAMENT VOLTS meter first indicates approximate voltage selected, and then indicates exact voltage selected. Pointer of SIGNAL meter can be adjusted to redline for each position of range switch.	Higher echelon repair required.
Set the ON-OFF switch to OFF -----	PILOT lamp goes out -----	Higher echelon repair required.
Set all switches to positions specified on tube test data roll chart for available tube known to be in good condition, insert tube in appropriate tube socket, and set the ON-OFF switch to ON.	PILOT lamp lights -----	Higher echelon repair required.
Set SHORT TEST switch to V position and depress PRESS TO TEST P1 switch.	FIL. CONT. SHORT lamp lights -----	Replace FIL. CONT. SHORT lamp (par. 39b). Higher echelon repair required.
Adjust FILAMENT fine control -----	FILAMENT VOLTS meter indicates exact voltage selected.	Higher echelon repair required.
Set PLATE-SCREEN RANGE switch to position specified for tube on tube test data roll chart and adjust PLATE and SCREEN fine controls.	PLATE and SCREEN VOLTS meter indicates exact voltage indicated for tube on tube test data roll chart.	Replace tubes V1 and V3 (pars. 36 and 37). Higher echelon repair required.
Set BIAS RANGE switch to position specified for tube on tube test data roll chart, and adjust BIAS fine control.	GRID BIAS VOLTS meter indicates exact voltage indicated for tube on tube test data roll chart.	Replace tube V2 (pars. 36 and 37). Higher echelon repair required.

Set quality SHUNT control to position indicated for tube on tube test data roll chart, and set GM-SIGNAL RANGE switch to position F.		
Depress PRESS TO TEST P4 switch to locking position.	Pointer of PERCENT QUALITY meter may deflect slightly.	
Adjust GM CENTERING control -----	PERCENT QUALITY meter indicates exactly zero.	Higher echelon repair required.
Release PRESS TO TEST P4 switch -----	PERCENT QUALITY meter remains on zero.	Higher echelon repair required.
Set GM-SIGNAL RANGE switch to position specified for tube on tube test data roll chart.	Pointer of PERCENT QUALITY meter deflects.	Higher echelon repair required.
Adjust SIGNAL-V.R. fine control -----	Pointer of SIGNAL meter adjusts exactly to redline.	Higher echelon repair required.
Depress the appropriate PRESS TO TEST switch to locking position and read percent quality of tube on PERCENT QUALITY meter.	PERCENT QUALITY meter indication is above minimum requirement of tube as specified on tube test data roll chart.	Higher echelon repair required.

36. Removal and Replacement of Chassis

a. Removal.

- (1) Unsnap the latches and open the cover of the tube tester.
- (2) Remove the 14 screws that secure the front panel to the case.
- (3) Lift the panel and the chassis from the case by the handles mounted on the panel.
- (4) Slowly lift the tube tester case upward until it is clear of the chassis.

b. Replacement.

- (1) Position the tube tester case so that the handle is forward.
- (2) Carefully lower the tube tester into the case. Be sure that no wires are caught between the front panel and the edge of the case.
- (3) Replace the screws that secure the front panel to the case.

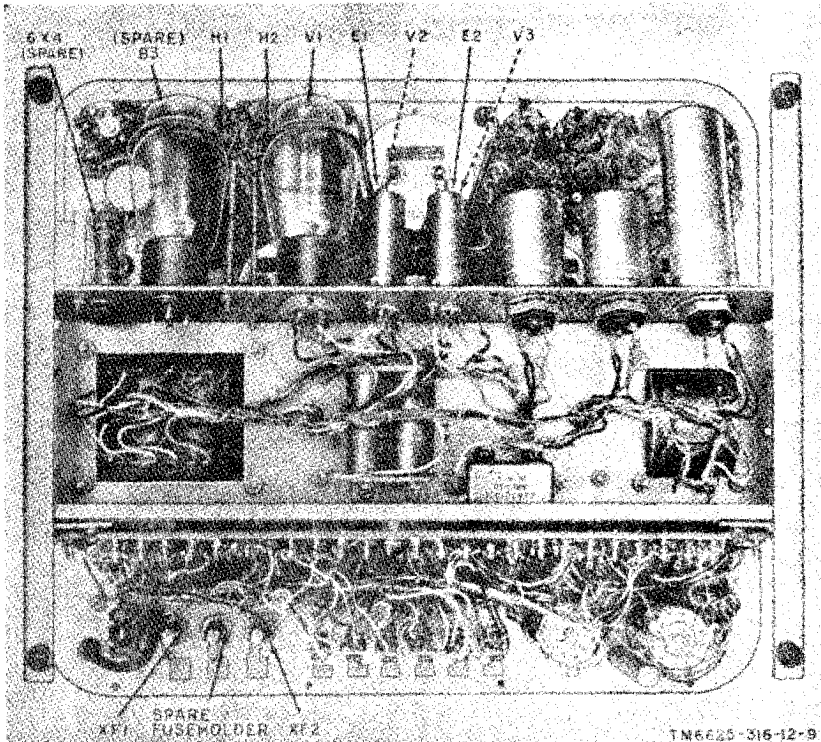

Figure 8. Test Set, Electron Tube TV-2(*)/U, rear view of Chassis.

37. Tube Replacement

(fig. 8)

When trouble occurs, check the power cord connection and the control settings before removing any tubes. If tube failure is suspected, use the tube substitution method (*a* below) to check the tubes.

Caution: Do not rock or rotate a tube when removing it from a socket; pull it straight out with a tube puller.

a. Tube Substitution Method. Replace a suspected tube (*b* below) with a new tube. If the equipment still does not work, remove the new tube and put back the original tube. Repeat this procedure with each suspected tube until the defective tube is located.

b. Replacing Tubes in Test Set, Electron Tube TV-2()/U.* Check the tubes in the tube tester as follows:

- (1) Remove the chassis from the case (par. 36).
- (2) Remove the shields of the 6X4 or 6X4W tubes (V2 and V3) by pressing down on the shield and rotating counterclockwise until it is released.
- (3) Release the retainer of the 83 tube (V1) by pressing down on the spring which engages the threaded portion of the supporting stud; remove the retainer from the tube.
- (4) Use a tube puller to remove the tube. If a tube puller is not available, allow the tube to cool, and then grasp it, and pull the tube straight up.
- (5) If a tube marking has become illegible, label the tube as soon as it is removed.
- (6) Replace the tube (*a* above) with one of the running spares.
- (7) Set the tube (or a replacement) in the socket and secure it (by replacing tube retainer or shield).
- (8) Replace the chassis in the case (par. 36b).

38. Preferred-Type Tubes

A preferred-type electron tube, type 6X4W, has been developed as a direct replacement for nonpreferred-type 6X4. The 6X4W tube is used in the power supply. When replacement of a 6X4 type tube is necessary, replace it with a 6X4W type tube. Do not substitute a 6X4 tube for a 6X4W tube.

39. Replacement of Fuses and Lamps

The two fuses (F1 and F2) and the two glowlamps (11C and 12C) are removable from the front panel of the tube tester.

a. Replacement of Fuses. Fuses F1 and F2 are 3-ampere, 250-volt, $\frac{1}{4}$ - by $1\frac{1}{4}$ -inch, cartridge-type fuses (fig. 5). To remove a fuse, press the fuseholder cap and turn it counterclockwise. Remove the cap, and then remove the fuse from its holder.

Caution: The fuses are rated at 3 amperes each. When replacing a fuse, be careful to use a fuse of the same rating.

b. Replacement of Lamps. Lamps 11C and 12C are glowlamps (fig. 1) with miniature-bayonet bases. To remove a glowlamp, unscrew the indicator light lens, press the lamp inward and rotate it counterclockwise, and withdraw the glowlamp from its socket.

CHAPTER 4
ORGANIZATIONAL MAINTENANCE

40. General

Organizational maintenance of the tube tester is limited to preventive maintenance (par. 42) and to the replacement of the test adapters (fig. 10), electrical plug connector, electrical clip, insulator clip, knobs (04 through 031, fig. 1), indicator light lens, and electron tube retainer and shield. The operating instructions for the tube tester are contained in paragraphs 13 through 31.

41. Tools and Materials Required

The tools and materials required for organizational maintenance are as follows:

a. Tools. The only tools required are those tools normally available to the repairman-user because of his assigned mission.

b. Materials.

- (1) Cleaning compound.
- (2) Cleaning cloth.
- (3) Sandpaper, fine.

42. Preventive Maintenance

a. DA Form 11-266. DA Form 11-266 (fig. 9) is a preventive maintenance checklist to be used by the second echelon. Items not applicable to the equipment are lined out in the figure. References to the ITEM block in the figure are to paragraphs that contain additional maintenance information pertinent to the particular item. Instructions for the use of the form appear on the form.

b. Items. The information shown in this subparagraph is supplementary to DA Form 11-266. The item numbers correspond to the ITEM numbers on the form.

Warning: Disconnect all power before performing the following operations. After power is disconnected, some capacitors still may retain dangerous voltages. Before touching exposed electrical parts, short-circuit the parts to ground. When maintenance is completed, replace the equipment in its case, reconnect the power, and check for satisfactory operation.

Item	Maintenance procedures
12	See that the electron tube shields for V2 and V3 are firmly in position and secure. See that the electron tube retainer for V1 is clamped tight.
19	Inspect fixed capacitors on the underside of the tube tester chassis for leaks, bulges, and discoloration.

43. Visual Inspection

Before operating the equipment, inspect it. Inspection will save repair time and may also avoid further damage. Inspect the following for obvious defects:

- a. The seating of all tubes in their sockets.
- b. Wiring connections on the terminal board.
- c. Wiring connections to the switches and meters on the front panel.

44. Equipment Performance Checklist

a. *General.* The equipment performance checklist provides a procedure for systematically checking equipment performance. All corrective measures that the second echelon repairman can perform are given in the *Corrective measure* column. When using the checklist, start at the beginning and follow each step in order. If the corrective measures indicated do not fix the equipment, troubleshooting is required by higher echelon. Note on the repair tag how the equipment performed and the corrective measures that were taken.

b. *Procedure.* Place the tube tester in operation as shown in the checklist in *c* below.

LEGEND for marking conditions: Satisfactory, ✓ Adjustment, Repair or Replacement required, X. Defect corrected, (C)		DAILY CONDITION FOR MONTH OF																																							
NO.	DAILY ITEM	1	2	3	4	5	6	7	8	9	10	11	12	13	14	15	16	17	18	19	20	21	22	23	24	25	26	27	28	29	30	31	30	30	ECH-ELON						
		17	18	19	20	21	22	23	24	25	26	27	28	29	30	31	32	33	34	35	36	37	38	39	40	41	42	43	44	45	46	47	48	49	50	51					
1	CLEAN DIRT AND MOISTURE FROM EXPOSED SURFACES OF SWITCHES, KNOBS, JAGGERS, CONTROLS, METER WINDOWS, ETC.	/	/	/	/	/	/	/	/	/	/	/	/	/	/	/	/	/	/	/	/	/	/	/	/	/	/	/	/	/	/	/	/	/	/	/	/				
2	INSPECT FOR LOOSENESS OF EXTERIOR ITEMS SUCH AS SWITCHES, KNOBS, JAGGERS, CONTROLS AND PILOT LIGHTS.	/	/	/	/	/	/	/	/	/	/	/	/	/	/	/	/	/	/	/	/	/	/	/	/	/	/	/	/	/	/	/	/	/	/	/					
3	INSPECT CONTROLS FOR BINDING, SCRAPING TAP CONTROLS LIGHTLY FOR CUT-OUT DUE TO LOOSE CONTACTS.	/	/	/	/	/	/	/	/	/	/	/	/	/	/	/	/	/	/	/	/	/	/	/	/	/	/	/	/	/	/	/	/	/	/	/					
4	DURING OPERATION BE ALERT FOR ANY UNUSUAL PERFORMANCE OR CONDITION	/	/	/	/	/	/	/	/	/	/	/	/	/	/	/	/	/	/	/	/	/	/	/	/	/	/	/	/	/	/	/	/	/	/	/					
WEEKLY		CONDITION EACH WEEK					CONDITION					ADDITIONAL ITEMS FOR 3D AND 3D ECHELON INSPECTIONS																												CONDITION	
5	INSPECT CORDS, CABLES, WIRE AND SHEATH WORK FOR BREAKS, CUTS, KINKS, DEGRADATION, STRAIN AND FRAVING.	1ST	2D	3D	4TH	5TH	6TH	7TH	8TH	9TH	10TH	11TH	12TH	13TH	14TH	15TH	16TH	17TH	18TH	19TH	20TH	21TH	22TH	23TH	24TH	25TH	26TH	27TH	28TH	29TH	30TH	31ST	32ND	33RD	34TH						
6	INSPECT CABLES AND LEADS FOR WEAR, DAMAGE, CORROSION, AND SHORTS.																																								
7	HAND CHECK FOR LOOSENESS OF EXTERIOR ITEMS SUCH AS HANDLES, LATCHES, KINKS																																								
8	INSPECT TERMINALS AND CONNECTIONS FOR CORROSION, CRACKS, AND DISCOLORATION.																																								
9	INSPECT TERMINALS AND CONNECTIONS FOR CORROSION, CRACKS, AND DISCOLORATION.																																								
10	INSPECT EXPOSED METAL SURFACES FOR RUST AND CORROSION																																								
11	INSPECT METERS FOR DAMAGED GLASS AND CASES.																																								
ADDITIONAL ITEMS FOR 3D AND 3D ECHELON INSPECTIONS												ADDITIONAL ITEMS FOR 3D AND 3D ECHELON INSPECTIONS																												CONDITION	
12	INSPECT KEYS OF READILY ACCESSIBLE ITEMS OF A PLUG-OUT NATURE: SWITCHES, FUSES, CABLES, PLUGS, LAMPS, ETC. DO NOT REMOVE, ROCK OR TWIST TO INSPECT. USE ONLY A DIRECT PRESSURE TO INSURE THE ITEM IS FULLY SEATED. PARA 42																																								
13	INSPECT FOR CRACKS AND DISCOLORATION OF SWITCHES, KNOBS, CONTROLS, AND PILOT LIGHTS.																																								
14	INSPECT KEYS AND CIRCUIT BREAKERS FOR WEAR AND DAMAGE.																																								
15	INSPECT TERMINALS AND CONNECTIONS FOR CORROSION, CRACKS, AND DISCOLORATION.																																								
16	INSPECT TERMINALS AND CONNECTIONS FOR CORROSION, CRACKS, AND DISCOLORATION.																																								
17	INSPECT TERMINALS AND CONNECTIONS FOR CORROSION, CRACKS, AND DISCOLORATION.																																								
18	INSPECT TERMINALS AND CONNECTIONS FOR CORROSION, CRACKS, AND DISCOLORATION.																																								
19	INSPECT TERMINALS AND CONNECTIONS FOR CORROSION, CRACKS, AND DISCOLORATION.																																								
20	CLEAN AND TIGHTEN SWITCHES, CONTROLS, AND PILOT LIGHTS. CLEAN INTERIOR OF CHASSIS AND CABINETS. PARA 42																																								
21	INSPECT TERMINALS AND CONNECTIONS FOR CORROSION, CRACKS, AND DISCOLORATION.																																								
22	INSPECT TERMINAL BLOCKS FOR LOOSE CONNECTIONS, CRACKS AND BREAKS.																																								
23	INSPECT BASKETS AND BUSHINGS FOR WEAR AND DAMAGE.																																								
24	INSPECT TERMINALS AND CONNECTIONS FOR CORROSION, CRACKS, AND DISCOLORATION.																																								
25	INSPECT TERMINALS AND CONNECTIONS FOR CORROSION, CRACKS, AND DISCOLORATION.																																								
ADDITIONAL ITEMS FOR 3D AND 3D ECHELON INSPECTIONS												IF DEFICIENCIES NOTED ARE NOT CORRECTED DURING THE INSPECTION, INDICATE ACTION TAKEN FOR CORRECTION. (Continue on page 4, if more space is needed). ITEM 11, METER GLASS CRACKED, REPORTED TO HIGHER ECHELON MAINTENANCE FOR REPLACEMENT.																													

Figure 9. DA Form 11-266, pages 2 and 3 (as used by second echelon).

TM625-316-12-8

c. *Equipment Performance Checklist.*

	Step	Action or condition	Normal indication	Corrective measure
S T A R T	1	Connect the TV-2(*)/U to a power source and set the ON-OFF switch to ON.	PILOT lamp lights -----	Replace PILOT lamp (par. 39b). Replace fuses F1 and F2 (par. 39a). Higher echelon repair required.
	2	Set FILAMENT RANGE switch to several voltages and adjust FILAMENT fine control for each of the voltages selected.	Pointer of FILAMENT VOLTS meter indicates approximate voltage selected, then indicates exact voltage selected.	Higher echelon repair required.
	3	Set GM-SIGNAL RANGE switch to each position and adjust SIGNAL-V.R. fine control for each position.	Pointer of SIGNAL meter can be adjusted to redline for each position of range switch.	Higher echelon repair required.
	4	Set the ON-OFF switch to OFF -----	PILOT lamp goes out -----	Higher echelon repair required.
E Q U I P . P E R F .	5	Set all switches to positions specified on tube test data roll chart for an available octal tube known to be in good condition, insert tube in OCTAL tube socket, and set the ON-OFF switch to ON.	PILOT lamp lights -----	Higher echelon repair required.
	6	Set SHORT TEST switch to V position and depress PRESS TO TEST P1 switch.	FIL. CONT. SHORT lamp lights ----	Replace FIL. CONT. SHORT lamp (par. 39b). For TV-2B/U only, replace test adapter X3B (par. 45). Higher echelon repair required.
	7	Adjust FILAMENT fine control -----	FILAMENT VOLTS meter indicates exact voltage selected.	

EQUIPMENT PERFORMANCE

8	Set PLATE-SCREEN RANGE switch to position specified for tube on tube test data roll chart and adjust PLATE and SCREEN fine controls.	PLATE and SCREEN VOLTS meter indicates exact voltage indicated for tube on tube test data roll chart.	Replace tubes V1 and V3 (pars. 36 and 37). For TV-2B/U only, replace test adapter X3B (par. 45). Higher echelon repair required.
9	Set BIAS RANGE switch to position specified for tube on tube test data roll chart, and adjust BIAS fine control.	GRID BIAS VOLTS meter indicates exact voltage indicated for tube on tube test data roll chart.	Replace tube V2 (pars. 36 and 37). For TV-2B/U only, replace test adapter X3B (par. 45). Higher echelon repair required.
10	Set quality SHUNT control to position indicated for tube on tube test data roll chart, and set GM-SIGNAL RANGE switch to position F.		
11	Depress PRESS TO TEST P4 switch to locking position.	Pointer of PERCENT QUALITY meter may deflect slightly.	
12	Adjust GM CENTERING control -----	PERCENT QUALITY meter indicates exactly 0.	Higher echelon repair required.
13	Set GM-SIGNAL RANGE switch to position specified for tube on tube test data roll chart.	Pointer of PERCENT QUALITY meter deflects.	Higher echelon repair required.
14	Adjust SIGNAL-V.R. fine control -----	Pointer of SIGNAL meter adjusts exactly to redline.	Higher echelon repair required.
15	Depress the appropriate PRESS TO TEST switch to locking position and read percent quality of tube on PERCENT QUALITY meter.	PERCENT QUALITY meter indication is above minimum requirement of tube as specified on tube test data roll chart.	Higher echelon repair required.
16	For TV-2B/U only, insert a 9-pin tube known to be in good condition into the NOVAL tube socket and test as specified on tube test data roll chart.	Tube checks good -----	Replace test adapter X7B (par. 45). Higher echelon repair required.

	Step	Action or condition	Normal indication	Corrective measure
EQUIP. PERF.	17	For TV-2B/U only, insert a 7-pin miniature tube known to be in good condition into the MIN. SEVEN tube socket and test as specified on tube test data roll chart.	Tube checks good -----	Replace test adapter X10B (par. 45). Higher echelon repair required.
	18	Insert an 8-pin long lead subminiature tube known to be in good condition into the SUB-MIN. EIGHT LONG LEAD tube socket and test as specified on tube test data roll chart.	Tube checks good -----	Replace test adapter X13B (par. 45). Higher echelon repair required.
	19	Insert a tube that has external connections for plate and grid and known to be good into appropriate tube socket and test as specified on tube test data roll chart.	Tube checks good -----	Replace electrical clips A and B. Higher echelon repair required.
STOP	20	Set ON-OFF switch to OFF.		

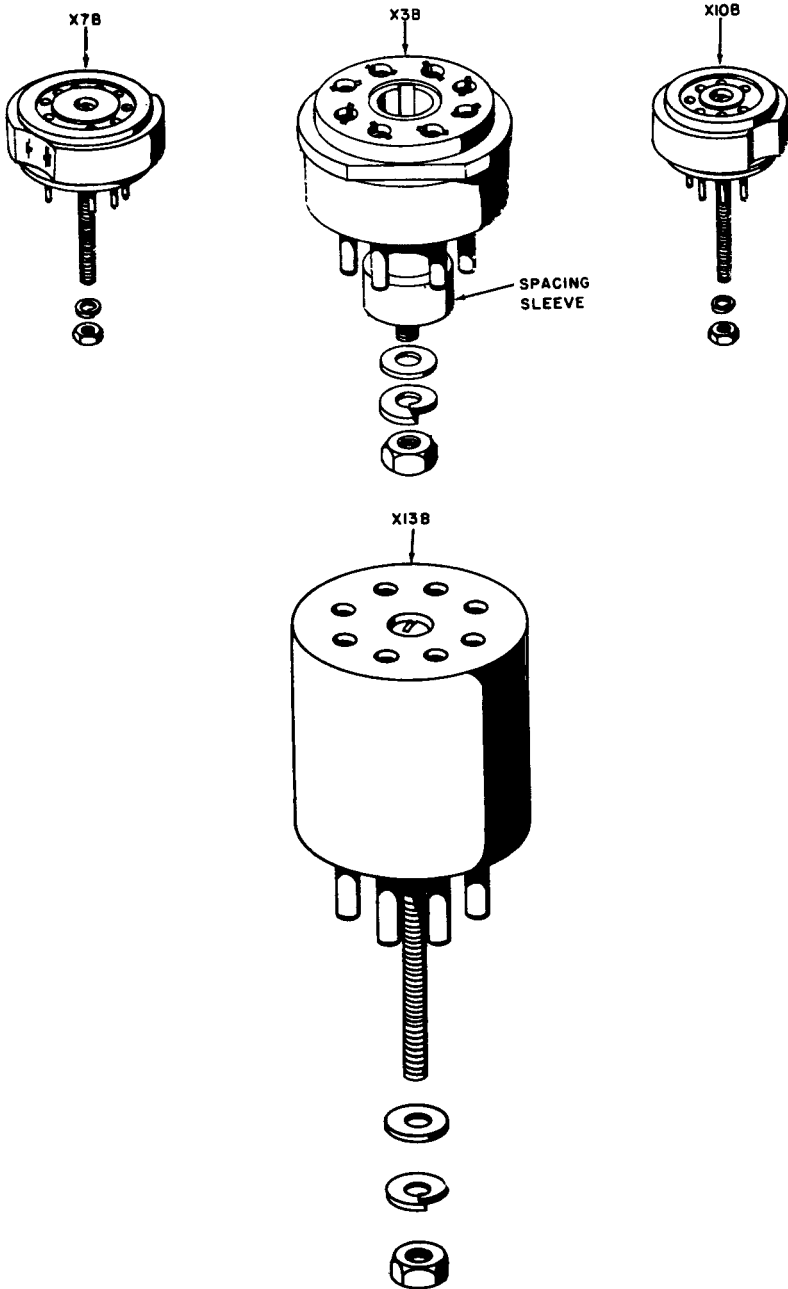

NOTE:
X3B, X7B, AND X10B USED
IN TV-2B/U ONLY, X13B USED
IN TV-2/U, TV-2A/U, AND
TV-2B/U.

TM6625-316-12-12

Figure 10. Test adapters.

45. Replacement of Test Adapters

(fig. 10)

Replace test adapter X13B (used in TV-2/U, TV-2A/U, and TV-2B/U) and test adapters X3B, X7B, and X10B (used in TV-2B/U only) as follows:

a. Removal.

- (1) Remove the tube tester chassis (par. 36) from the case.
- (2) Remove the hexagonal nut from the threaded stud of the test adapter to be replaced. Remove the spacing sleeve when replacing test adapter X3B.
- (3) Remove the test adapter from the test socket.

b. Replacement.

- (1) Plug the adapter into its corresponding test socket. Be sure to place the spacing sleeve over the threaded stud of test adapter X3B.
- (2) Replace and tighten the hexagonal nut.
- (3) Replace the tube tester chassis in the case.

CHAPTER 5
SHIPMENT, LIMITED STORAGE, AND DEMOLITION
TO PREVENT ENEMY USE

Section I. SHIPMENT AND LIMITED STORAGE

46. Disassembly of Equipment

a. Operate all switches and their controls to their safety positions (par. 15d) and disconnect the tube tester from the ac power supply.

b. Remove the power cord plug from the ac source.

c. Wind the power cord around the brackets on the front panel and insert the plug into the dummy power cord receptacle that is mounted on the front panel.

d. Close the case and latch it securely.

47. Repackaging for Shipment or Limited Storage

(fig. 11)

The exact procedure for repackaging depends on the material available and the conditions under which the equipment is to be shipped or stored. Adapt the procedures outlined below whenever circumstances permit. The information concerning the original packaging (pars. 8 and 9) will also be helpful.

a. Material Requirements. The following materials are required for packaging the tube tester. For stock numbers of materials, consult SB 38-100.

Material	Quantity
Waterproof wrapping paper -----	18 sq ft
Fiberboard, corrugated, single-face (flexible) -----	35 sq ft
Tape, pressure-sensitive adhesive, waterproof (3-inch) -----	12 ft
Tape, paper, gummed (sealing and securing) (3-inch) _____	10 ft
Strapping, flat, steel (5/8 - x 0.02-inch) _____	13 ft
Strapping seals -----	2 each
Wooden shipping box (19¼ x 18¼ x 10 ¾ inches inside dimensions).	1 ea

b. Packaging.

- (1) Package each technical manual within a close-fitting bag fabricated of waterproof paper. Seal each bag with waterproof pressure-sensitive tape.
- (2) Running spares are stored in designated positions on the inside cover and chassis (figs. 1 and 8) of the tube tester.
- (3) Package the tube tester in a double wrap of flexible corrugated fiberboard. Secure the ends of the package with waterproof pressure-sensitive tape.

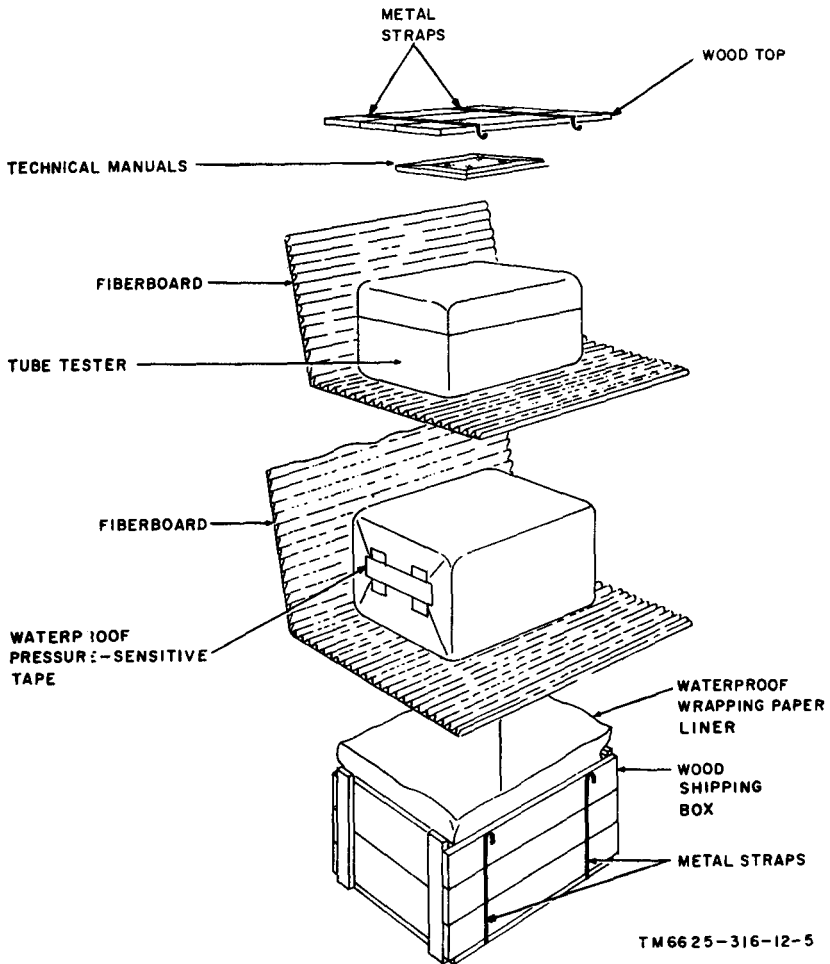

Figure 11. Field repackaging diagram.

c. Packing.

- (1) Line the wooden shipping box with waterproof wrapping paper.
- (2) Place the wrapped tube tester in the wooden shipping box.
- (3) Seal the waterproof wrapping paper liner with waterproof pressure-sensitive tape.
- (4) Place the wrapped technical manuals on top of the sealed waterproof wrapping paper liner and secure them with waterproof pressure-sensitive tape.
- (5) Nail the wooden cover in place.
- (6) For intertheater shipment, secure the wooden shipping box with metal strapping.

Section II. DEMOLITION OF MATERIEL TO PREVENT ENEMY USE

48. Authority for Demolition

The destruction procedures outlined in paragraph 49 will be used to prevent the enemy from using or salvaging this equipment. Demolition of the equipment will be accomplished only upon the order of the commander.

49. Methods of Destruction

Any or all of the methods of destruction given below may be used. The time available will be the major determining factor for the methods to be used when destruction of the equipment is undertaken. The tactical situation also will determine in what manner the destruction order will be carried out.

a. Smash. Smash meters, switches and controls, the instrument panel and chassis, tubes, capacitors, resistors, transformers, the roll chart housing, and the case; use sledges, axes, handaxes, pick-axes, hammers, crowbars, or heavy tools.

b. Cut. Cut cords and wiring; use axes, handaxes, or machetes.

Warning: Be extremely careful with explosive and incendiary devices. Use these items only when the need is urgent.

c. Burn. Burn cords, wiring, the tube test data roll chart, and technical manuals; use gasoline, kerosene, oil, flamethrowers, or incendiary grenades.

d. Bend. Bend the panel, case, and chassis.

e. Disposal. Bury or scatter the destroyed parts in slit trenches, foxholes, or other holes, or throw them into streams.

APPENDIX I

REFERENCES

Following is a list of references applicable and available to the operator and unit repairman of Test Set, Electron Tube TV-2(*)/U:

FM 21-5	Military Training.
FM 21-6	Techniques of Military Instruction.
FM 21-30	Military Symbols.
SB 38-100	Preservation, Packaging, and Packing Materials, Supplies, and Equipment Used by the Army.
AR 320-5	Dictionary of United States Army Terms.
AR 320-50	Authorized Abbreviations and Brevity Codes.
TM 11-6625-316-12P	Operator's and Organizational Maintenance Repair Parts and Special Tools List and Maintenance Allocation Chart for Electron Tube Test Sets TV-2/U, TV-2B/U, and TV-2B/U.

APPENDIX II

MAINTENANCE ALLOCATION

1. Scope

a. This appendix assigns maintenance functions and repair operations to be performed by the lowest appropriate maintenance echelon. It also specifies the tools and other equipment authorized at each echelon to perform the assigned maintenance functions.

b. Columns in the maintenance allocation chart are as follows:

- (1) *Part or component.* This column shows only the nomenclature or standard item name. Additional descriptive data are included only where clarification is necessary to identify the part. Components and parts comprising a major end item are listed alphabetically. Assemblies and subassemblies are in alphabetical sequence with their components listed alphabetically immediately below the assembly listing.
- (2) *Maintenance function.* This column indicates the various maintenance functions allocated to the echelon capable of performing the operations.
 - (*a*) *Service.* To clean, to preserve, and to replenish fuel and lubricants.
 - (*b*) *Inspect.* To verify serviceability and to detect incipient electrical or mechanical failure by scrutiny.
 - (*c*) *Test.* To verify serviceability and to detect incipient electrical or mechanical failure by use of special equipment such as gages, meters, and other test devices.
 - (*d*) *Replace.* To substitute service assemblies, subassemblies, and parts for unserviceable components.
 - (*e*) *Repair.* To restore an item to serviceable condition through correction of a specific failure or unserviceable condition. This function includes but is not limited to, inspecting, cleaning, preserving, adjusting, replacing, welding, riveting, and straightening.
 - (*f*) *Rebuild.* To restore an item to a standard as near as possible to original or new condition in appearance, performance, and life expectancy. This is accomplished

through the maintenance technique of complete disassembly of the item, inspection of all parts or components, repair or replacement of worn or unserviceable elements using original manufacturing tolerances and/or specifications and subsequent reassembly of the item.

- (3) *1st, 2d, 3rd, 4th, 5th echelon.* The symbol X indicates the echelon responsible for performing that particular maintenance operation, but does not necessarily indicate that repair parts will be stocked at that level. Echelons higher than the echelon marked by X are authorized to perform the indicated operation.
- (4) *Tools required.* This column indicates codes assigned to each individual tool equipment, test equipment, and maintenance equipment referenced. The grouping of codes in this column of the maintenance allocation chart indicates the tool, test, and maintenance equipment required to perform the maintenance function.
- (5) *Remarks.* Entries in this column will be utilized when necessary to clarify any of the data cited in the preceding columns.

c. Columns in the allocation of tools for maintenance functions are as follows:

- (1) *Tools required for maintenance functions.* This column lists tools, test, and maintenance equipment required to perform the maintenance functions.
- (2) *1st, 2nd, 3rd, 4th, 5th echelon.* The dagger (†) symbol indicates the echelons allocated the facility.
- (3) *Tool code.* This column lists the tool code assigned.

2. Maintenance by Using Organizations

When this equipment is used by Signal services organizations organic to the theater headquarters or communication zones to provide theater communications, those maintenance functions allocated up to and including fourth echelon are authorized to the organization operating this equipment.

3. Mounting Hardware

The basic entries of the maintenance allocation chart do not include mounting hardware such as screws, nuts, bolts, washers, brackets, clamps, etc.

APPENDIX III
BASIC ISSUE ITEMS LIST

Section I. INTRODUCTION

1. Scope

a. General. This appendix lists items supplied for initial operation and for running spares. The list includes parts and material issued as *part* of the major end item, and all items authorized for basic operator maintenance of the equipment. End items of the equipment are issued on the basis of allowances prescribed in equipment authorization tables and other documents that are a basis for requisitioning.

b. Columns. The columns areas follows:

- (1) *Source, maintenance, and recoverability code.* Not used.
- (2) *Federal stock number.* This column lists the 11-digit Federal stock number.
- (3) *Designation by model.* Not used.
- (4) *Description.* Nomenclature or the standard item name and brief identifying data for each item are listed in this column. When requisitioning, enter the nomenclature and description.
- (5) *Unit of issue.* The unit of issue is the supply term by which the individual item is counted for procurement, storage, requisitioning, allowances, and issue purposes.
- (6) *Expendability.* Expendable items are indicated by the letter X; nonexpendable items are indicated by NX.
- (7) *Quantity authorized.* Under "Items Comprising an Operable Equipment," the column lists the quantity of items supplied for the initial operation of the equipment. Under "Running Spares and Accessory Items", the quantities listed are those issued initially with the equipment as spare parts. The quantities are authorized to be kept on hand by the operator for maintenance of the equipment.
- (8) *Illustration.* The "Item No." column lists the reference symbols used for identification of the items in the illustration or text of the manual. The numbers in the "Figure

No.” column refer to the illustrations where the part is shown.

2. Critical Items

A zero slash (ø) in the “Description” column indicates items that are expected to fail during the first year; also items that will make the equipment inoperative if they fail.

(1) PART OR COMPONENT	(2) MAINTENANCE FUNCTION	(3) 1ST ECH	(4) 2ND ECH	(5) 3RD ECH	(6) 4TH ECH	(7) 5TH ECH	(8) TOOLS REQUIRED	(9) REMARKS
TEST SET, ELECTRON TUBE TV-2/U; TV-2A,B/U	service		X				5	Visual only
	inspect		X					
	test				X	X	2,4	
	repair				X			
	calibrate					X	1,3,6	
rebuild					X			
ADAPTERS, TEST	replace	X						
CABLE ASSEMBLY, POWER ELECTRICAL	replace				X			Fabricate if required
CABLE, POWER, ELECTRICAL	replace				X			
CONNECTOR, PLUG, ELECTRICAL	replace		X					
CAPACITORS	replace				X			
CASE, ELECTRONIC EQUIPMENT	replace					X		Fabricate if required
	repair					X		
CATCH, LUGGAGE	replace				X			
GASKET	replace				X			
HANDLE	replace					X		Fabricate if required
	repair					X		
HINGE	replace					X		Fabricate if required
	repair					X		
COVER, ELECTRONIC EQUIPMENT	replace					X		Fabricate if required
	repair					X		
HINGE	replace					X		Fabricate if required
	repair					X		Fabricate if required
OPERATING, INSTRUCTIONS	replace				X			Fabricate if required
ROLL CHART HOUSING ASSEMBLY	replace					X		Fabricate if required
	repair					X		

(1)	(2)	(3)	(4)	(5)	(6)	(7)	(8)	(9)
PART OR COMPONENT	MAINTENANCE FUNCTION	1ST ECH	2ND ECH	3RD ECH	4TH ECH	5TH ECH	TOOLS REQUIRED	REMARKS
TV-2/U; TV-2A,B/U (continued)								
CHART (for tube test settings)	replace				X			
GEAR, SPUR	replace				X			
PIN, STRAIGHTENER, ELECTRON TUBE	replace	X						Available in tool kit TE-113 and TE-41
ROLLER, CHART	replace				X			
SPRING (for chart roller)	replace				X			
STRIKE, CATCH	replace				X			Fabricate if required
	repair				X			
CLAMP, ELECTRICAL	replace				X			
CLIP, ELECTRICAL	replace		X					
CONNECTORS	replace				X			
ELECTRON TUBES	replace	X						
FUSE, CARTRIDGE	replace	X						
FUSEHOLDER	replace				X			
GALVANOMETER	replace				X			
INSULATOR, BUSHING	replace				X			
INSULATOR, CLIP	replace		X					
INSULATOR, WASHER	replace				X			
KNOBS	replace		X					
LAMP, GLOW	replace	X						
LENS, INDICATOR LIGHT	replace		X					
LIGHT, INDICATOR	replace				X			
MULTIMETER, REPLACEMENT	replace				X			
RESISTORS	replace				X			
RETAINER, ELECTRON TUBE	replace		X					
SHIELD, ELECTRON TUBE	replace		X					
SOCKETS, ELECTRON TUBE	replace				X			
STAY, FOLDING	replace				X			
SWITCHES	replace				X			
TRANSFORMER, POWER, STEP-UP AND STEP-DOWN	replace				X			
VOLTMETER	replace				X			
WIRE, WS-16/U; WS-17/U	replace				X			

TV-2/U; TV-2A, B/U

(1) TOOLS REQUIRED FOR MAINTENANCE FUNCTIONS	(2) 1ST ECH	(3) 2ND ECH	(4) 3RD ECH	(5) 4TH ECH	(6) 5TH ECH	(7) TOOL CODE	(8) REMARKS
TV-2/U; TV-2A, B/U (continued)							
METER TEST SET TS-682/GSM-1					†	1	
MULTIMETER AN/URM-105				†	†	2	
TEST SET, ELECTRON TUBE AN/USM-31				†	†	3	
TOOL EQUIPMENT TK-21/G				†	†	4	
TOOLS AND TEST EQUIPMENT AVAILABLE TO THE REPAIRMAN USER BECAUSE OF HIS ASSIGNED MISSION		†				5	
VOLTMETER, METER ME-30/U				†	†	6	

TV-2/U; TV-2A, B/U

(1) SOURCE MAINTENANCE AND RECOVERABILITY CODE	(2) FEDERAL STOCK NUMBER	(3) DESIGNATION BY MODEL	(4) DESCRIPTION	(5) UNIT OF ISSUE	(6) EXPENDABILITY	(7) QUANTITY AUTHORIZED	(8) ILLUSTRATIONS		(9)
							FIGURE NO	ITEM NO	
			ITEMS COMPRISING AN OPERABLE EQUIPMENT						
			TEST SET, ELECTRON TUBE TV-2/U; TV-2A, B/U						
	6625-669-0263		TEST SETS, ELECTRON TUBE TV-2/U; TV-2A, B/U	ea	NX				
	Ord thru AGC		TECHNICAL MANUAL 11-6625-316-12	ea	X	2			
			TEST SET, ELECTRON TUBE: TV-2/U; TV-2A, B U. (Basic component)	ea	NX	1	1		
			RUNNING SPARES AND ACCESSORY ITEMS						
			TEST SET, ELECTRON TUBE TV-2/U; TV-2A, B/U						
	5960-188-0800		Ø ELECTRON TUBE: JAN type 6X4W	ea	X	1	7	V2 V3	
	5960-100-7323		Ø ELECTRON TUBE: JAN type 83	ea	X	1	7	V1	
	5920-189-0846		Ø FUSE, CARTRIDGE: Littlefuse No. 312003	ea	X	5	9	F1 F2	
	5240-223-9100		LAMP, GLOW: GE No. NE51	ea	X	1	1	11C 12C	

